







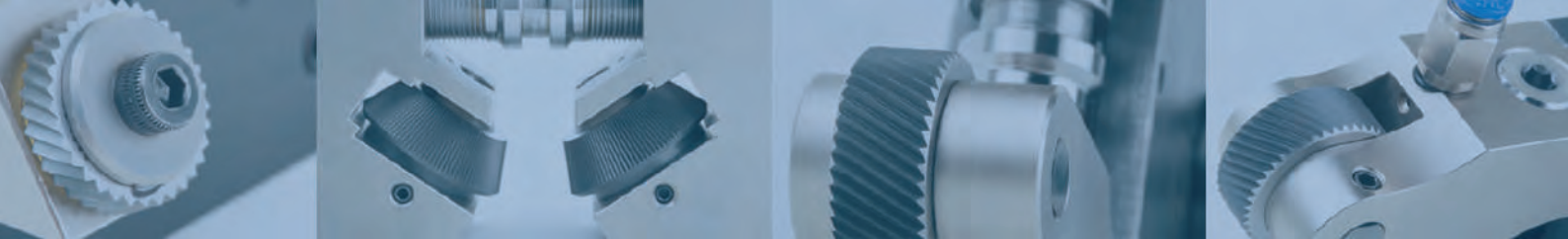

TECNOLOGÍA DE MOLETEADO

KNURLING TECHNOLOGY







		Página Page
	► <b>Información técnica sobre moleteado</b> Technical information about knurling	4
	► <b>Moletas</b> Knurls	14
	► <b>Moleteadores por deformación</b> Form knurling tools	17
<b>Gama básica</b> Basic range	• M1 .....	18
	• M2 .....	19
	• M3 .....	20
	• M7 .....	21
	• KM1-M7 .....	22
	<b>1 MOLETA · 1 KNURL</b>	
	• M6 .....	23
• M8 .....	24	
• M20 .....	25	
• M4 .....	26	
• M10 .....	27	
• M19 .....	28	
• M15 .....	29	
<b>2 MOLETAS · 2 KNURLS</b>		
• M12 .....	30	
• M9 .....	31	
• M21 .....	32	
• M5 .....	33	
• M11 .....	34	
• M16 .....	35	
• M22 - A .....	36	
• M22 - B .....	37	
• M23 - A .....	38	
• M23 - B .....	39	
<b>3 MOLETAS · 3 KNURLS</b>		
• M17 10/ M17 20 .....	40	
• M17 15/ M17 25 .....	41	
	► <b>Moleteadores por corte</b> Cut- knurling tools	
	<b>1 MOLETA · 1 KNURL</b>	
	• MFS 89 .....	42
	• MFS1 14 .....	43
	• MFS 14 .....	44
	• MFS 21 .....	45
	• MFS 32 .....	46
	• MFS 42 .....	47
	<b>2 MOLETAS · 2 KNURLS</b>	
	• MF 89 .....	48
	• MF1 14 .....	49
	• MF 14 .....	50
	• MF 21 .....	51
	• MF 21 VDI .....	52
	• MF 42 .....	53
	► <b>KITS</b> .....	54



### 1. Moleteado por deformación

Con este tipo de moleteado las estrías se generan por deformación del material, al ejercer las moletas presión sobre la pieza mientras gira. Este método no implica arranque de material por lo que no hay generación de virutas. Debido a la deformación del material se produce un incremento del diámetro de la pieza. El valor del incremento es variable, ya que depende del material de la pieza mecanizada y de la forma y paso de las estrías generadas (ver tabla página 10).

1. El moleteado por deformación es imperativo cuando se usa la técnica del moleteado radial (plongée).
2. Cuando el perfil a mecanizar es de forma RGV, RKE, RKV.
3. Cuando es necesario que el diámetro final de la pieza sea mayor que el diámetro de partida.
4. Cuando hay que realizar un moleteado en el fondo de una garganta.
5. Para realizar moleteados hasta una cara.
6. Para moletear en conos o caras frontales.

### 2. Moleteado por corte

En el moleteado por corte las estrías se generan por arranque de material. Este tipo de moleteado no genera sobreesfuerzos sobre la máquina y en muchos casos se obtiene un moleteado de mayor calidad y precisión.

Las herramientas utilizadas para esta técnica de moleteado llevan las moletas con un ángulo de inclinación de 30° respecto al eje de giro de la pieza. Esta inclinación hace que la moleta vaya cortando las estrías según gira y avanza a lo largo de la generatriz de la pieza.

El moleteado por corte no genera incremento del diámetro de la pieza mecanizada, ya que en teoría no hay deformación del material. Aunque cabe resaltar que la realidad es que siempre hay un leve desplazamiento del material, que si bien no es de la misma magnitud que el que se genera a por el moleteado por deformación, hay que tenerlo en cuenta cuando la pieza a realizar requiere de cierta precisión en el diámetro final.

Este sistema de moleteado no es aplicable en todos los casos. Solo los perfiles RAA, RBL, RBR y RGE se pueden ejecutar con las herramientas de moletear por corte.

1. El moleteado por corte posibilita la ejecución de piezas tubulares de paredes finas, imposibles de realizar mediante moleteado por deformación.
2. Cuando el material a moletear no es deformable como plásticos, nylon, hierro fundido.

### 1. Form knurling

In form knurling the teeth are generated by deformation of the material, because the knurls exert pressure on the piece while it turns. This method is made without removing material so no chips are produced. Due to deformation of the material the diameter of the piece is increased. The value of this increase is variable as it depends on the material of the piece machined and the form and pitch of the teeth generated (see table page 10).

1. Form knurling is imperative when a radial knurling technique (plongée) is used.
2. When the profile to machine is RGV, RKE, RKV.
3. When the final diameter of the piece needs to be bigger than the starting diameter.
4. When you have to make a knurling in the bottom of a throat.
5. To make knurling till a face.
6. To knurling in cones or front faces.

### 2. Cut-knurling

In cut-knurling the teeth are generated by removing material. This type of knurling does not generate overstrain on the machine and in many cases a higher quality and more accurate knurling is obtained.

The tools used for this knurling technique fit knurls with a 30° angle in relation to the rotation axis of the piece. Due to this inclination the knurls cut the teeth while they are turning along the piece.

The cut-knurling system does not generate an increase in the diameter of the machined piece as in theory the material is not deformed. Although it must be stated that there is always a slight displacement of the material that even though it is not of the same magnitude as that generated by form knurling, it must be taken into account when the piece to be made requires a certain precision in the final diameter.

This knurling system is not applicable in all cases. Only RAA, RBL, RBR and RGE profiles can be run with cut-knurling tools.

1. Cut-knurling makes it possible to execute thin walled tubular pieces, whereas with form knurling it is impossible.
2. When the material to be knurled is not deformable as plastics, nylon, cast iron.



# TÉCNICAS DE MOLETEADO

## KNURLING TECHNIQUES





Basicamente existen dos técnicas de moleteado.

There are basically two knurling techniques.

### 1. MOLETEADO CON AVANCE RADIAL (Tipo R)

### 1. RADIAL FEED KNURLING (R type)

El moleteado radial es aquel en el que la longitud del moleteado en la pieza coincide con el espesor de la moleta a utilizar, por lo tanto la herramienta de moletear solo hay que desplazarla radialmente (avance normalmente representado con la letra R ).

Radial knurling is one in which the length of the knurling in the piece coincides with the thickness of the knurl, therefore the knurling tool is to be moved radially (feed usually represented with the letter R ).

En esta técnica de moleteado no es necesario que la moleta vaya biselada, si bien siempre es mejor utilizar moletas biseladas para evitar una rotura prematura de las esquinas de los dientes. Los biseles confieren robustez a los cantos de las moletas.

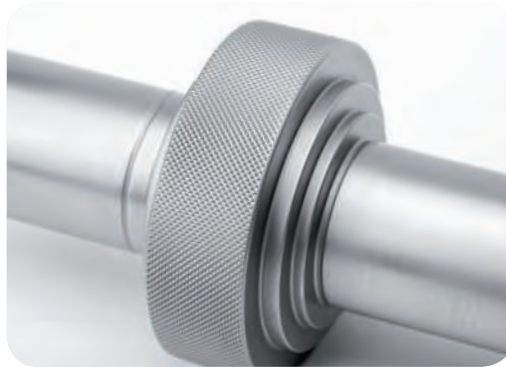

In this knurling technique it is not necessary to use beveled knurls, although it is always better so as to avoid premature breakage of the teeth angles. The bevels give strength to the edges of the knurls.

This knurling technique is only applicable to form knurling. It is never applicable to cut-knurling.

**Esa técnica de moleteado solo es utilizable con herramientas de moletear por deformación. Nunca con herramientas de moletear por corte.**

**This knurling technique is only applicable in form knurling. Never in cut-knurling.**

### 2. MOLETEADO CON AVANCE AXIAL (Tipo F)

### 2. AXIAL FEED KNURLING (F type)

El moleteado axial es aquel en el que la longitud del moleteado en la pieza es mayor que el espesor de la moleta a utilizar, por lo tanto la herramienta de moletear hay que desplazarla axialmente (avance normalmente representado con la letra F ) hasta alcanzar la longitud de moleteado total requerida.

In axial knurling the length of knurling piece is longer than the thickness of the knurl, therefore the knurling tool has to move axially (feed usually represented with the letter F ).

Esta técnica de moleteado es utilizable tanto para las herramientas de moletear por deformación como las que trabajan por corte. En el caso de las herramientas de moletear por deformación, las moletas han de llevar biseles imperativamente. En el caso de las herramientas de moletear por corte las moletas no tienen que estar biseladas.

This knurling technique is applicable to both form knurling tools and cut-knurling tools. In form knurling tools, the knurls must be beveled. In cut-knurling tools, the knurls must be unbeveled.

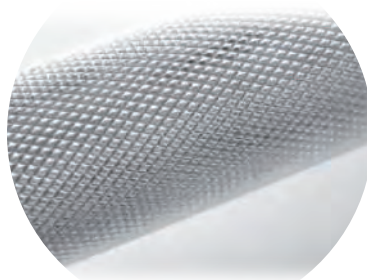



## ELECCIÓN DE LA HERRAMIENTA DE MOLETEADO CHOOSING THE MOST SUITABLE KNURLING TOOL



En muchos casos un mismo tipo de moleteado se puede realizar con diferentes tipos de herramientas. De presión de corte, de una o varias moletas.

In many cases the same type of knurling can be made using different types of tools. Pressure knurling tools or cut-knurling tools of one knurl or more.

En el siguiente cuadro detallamos para cada tipo de moleteado, con qué herramienta se puede realizar y de qué manera.

The following table shows which kind of tool can be used for each type of knurling.

### + Moleteados mecanizables con herramientas de deformación Allowed knurling for form knurling tools

Tipo de moleteado Type of knurling	Herramienta Tool	Moleta Knurl	Avance radial Radial feed [R]	Avance axial Axial feed [F]
RAA	De una moleta One knurl	AA	SI / YES	SI / YES
	De dos moletas Two knurls	AA + AA	SI / YES	SI / YES
	De tres moletas Three knurls	AA + AA + AA	NO / NO	SI / YES
RBR	De una moleta One knurl	BR	SI / YES	SI / YES
	De dos moletas Two knurls	BR + BR	SI / YES	SI / YES
	De tres moletas Three knurls	BR + BR + BR	NO / NO	SI / YES
RBL	De una moleta One knurl	BL	SI / YES	SI / YES
	De dos moletas Two knurls	BL + BL	SI / YES	SI / YES
	De tres moletas Three knurls	BL + BL + BL	NO / NO	SI / YES
RGE	De una moleta One knurl	GV	SI / YES	NO / NO
	De dos moletas Two knurls	BL + BR	SI / YES	SI / YES
	De tres moletas Three knurls	BL + BR + BR	NO / NO	SI / YES
RGV	De una moleta One knurl	GE	SI / YES	NO / NO
	De dos moletas Two knurls	-	-	-
	De tres moletas Three knurls	-	-	-
RKE	De una moleta One knurl	KV	SI / YES	NO / NO
	De dos moletas Two knurls	-	-	-
	De tres moletas Three knurls	-	-	-
RKV	De una moleta One knurl	KE	SI / YES	NO / NO
	De dos moletas Two knurls	-	-	-
	De tres moletas Three knurls	-	-	-



## ELECCIÓN DE LA HERRAMIENTA DE MOLETEADO CHOOSING THE MOST SUITABLE KNURLING TOOL



### + Moleteados mecanizables con herramientas de corte Allowed knurling for cut-knurling tools

Tipo de moleteado Type of knurling	Herramienta Tool	Versión Version	Moleta Knurl	Avance radial Radial feed (R)	Avance axial Axial feed (F)
RAA	De una moleta One knurl	Derecha Righth	BR 30°	NO / NO	SI / YES
		Izquierda Left	BL 30°	NO / NO	SI / YES
RBR 30°	De una moleta One knurl	Derecha Righth	AA	NO / NO	SI / YES
RBL 30°	De una moleta One knurl	Izquierda Left	AA	NO / NO	SI / YES
RGE 30°	De dos moletas Two knurls	-	AA + AA	NO / NO	SI / YES
	De tres moletas Three knurls	-	AA + AA + AA	NO / NO	SI / YES
RGE 45°	De dos moletas Two knurls	-	BL 15° + BR 15°	NO / NO	SI / YES
	De tres moletas Three knurls	-	BL 15° + BR 15° + BR 15°	NO / NO	SI / YES

### + Posibles problemas al moletear Possible problems and how to solve them

Problema Problem	Causa Cause	Solución Solution
Moleteado doble Double knurling	Escaso avance radial al comenzar el moleteado en la esquina de la pieza Low radial feed at the beginning of the knurling at the edge of the workpiece	Aumentar el avance radial al comienzo del moleteado Increase the radial feed at the beginning of knurling
	El perímetro de la pieza no es un múltiplo entero del paso The perimeter of the workpiece is not a whole multiple of the pitch	Tornear las piezas a un diámetro que proporcione un perímetro múltiplo entero del paso Modify the workpieces diameter. Perimeter has to be a whole multiple of pitch
Fácil rotura de las moletas Easy breaking of the knurls	Excesiva profundidad de moleteado Excessive knurling depth	Reducir la profundidad a valores admisibles para el paso utilizado Reduce the knurling depth to values according to the pitch used
Excesivo desgaste de las moletas Excessive wear of the knurls	Excesiva profundidad de moleteado Excessive knurling depth	Ajustar la profundidad de moleteado a los valores correctos Adjust the depth of the knurling to a correct values
	Las condiciones de trabajo no son las adecuadas Unappropriate work conditions	Revisar la velocidad de corte y el avance axial Check the cutting speed and axial feed





# MOLETEADO POR DEFORMACIÓN · VELOCIDADES DE CORTE Y AVANCES

## FORM KNURLING · FEED AND SPEED



Material Material	Ø Pieza Ø Piece	Ø Moleta Ø Knurl	VC (m/min) VC (m/min)	Avance radial (mm/rev) Radial feed (mm/rev) (R)	Avance axial (mm/rev) Axial feed (mm/rev) (F)			
					Paso (mm) Pitch (mm)			
					0.3 + 0.6	0.6 + 1.2	1.2 + 1.6	1.6 + 2.0
Acero 600 N/mm <sup>2</sup> 600 N/mm <sup>2</sup> steel	<10 mm	10 / 15 mm	20 ÷ 50	0.05 ÷ 0.10	0.15	0.10	0.08	0.07
	10 - 50 mm	15 / 20 mm	25 ÷ 55		0.20	0.15	0.13	0.10
		25 mm	30 ÷ 60		0.25	0.20	0.15	0.13
	50 - 100 mm	20 / 25 mm	30 ÷ 60		0.25	0.20	0.15	0.13
	100 - 200 mm	20 / 25 mm	30 ÷ 60		0.25	0.20	0.15	0.13
200 - 300 mm	25 mm	30 ÷ 60	0.25	0.20	0.15	0.13		
Acero 900 N/mm <sup>2</sup> 900 N/mm <sup>2</sup> steel	<10 mm	10 / 15 mm	15 ÷ 40	0.04 ÷ 0.08	0.12	0.08	0.05	0.04
	10 - 50 mm	15 / 20 mm	20 ÷ 45		0.15	0.10	0.08	0.06
		25 mm	25 ÷ 50		0.20	0.15	0.10	0.08
	50 - 100 mm	20 / 25 mm	25 ÷ 50		0.20	0.15	0.10	0.08
	100 - 200 mm	20 / 25 mm	25 ÷ 50		0.20	0.15	0.10	0.08
200 - 300 mm	25 mm	25 ÷ 50	0.20	0.15	0.10	0.08		
Acero inoxidable Stainless steel	<10 mm	10 / 15 mm	15 ÷ 40	0.04 ÷ 0.08	0.12	0.08	0.05	0.04
	10 - 50 mm	15 / 20 mm	20 ÷ 45		0.15	0.10	0.08	0.06
		25 mm	25 ÷ 50		0.20	0.15	0.10	0.08
	50 - 100 mm	20 / 25 mm	25 ÷ 50		0.20	0.15	0.10	0.08
	100 - 200 mm	20 / 25 mm	25 ÷ 50		0.20	0.15	0.10	0.08
200 - 300 mm	25 mm	25 ÷ 50	0.20	0.15	0.10	0.08		
Acero fundido Cast steel	<10 mm	10 / 15 mm	20 ÷ 40	0.05 ÷ 0.10	0.15	0.10	0.08	0.07
	10 - 50 mm	15 / 20 mm	25 ÷ 45		0.20	0.15	0.13	0.10
		25 mm	30 ÷ 50		0.25	0.20	0.15	0.13
	50 - 100 mm	20 / 25 mm	30 ÷ 50		0.25	0.20	0.15	0.13
	100 - 200 mm	20 / 25 mm	30 ÷ 50		0.25	0.20	0.15	0.13
200 - 300 mm	25 mm	30 ÷ 50	0.25	0.20	0.15	0.13		
Aluminio Aluminium	<10 mm	10 / 15 mm	25 ÷ 45	0.05 ÷ 0.10	0.12	0.08	0.05	0.04
	10 - 50 mm	15 / 20 mm	30 ÷ 50		0.20	0.15	0.10	0.06
		25 mm	35 ÷ 60		0.25	0.20	0.15	0.13
	50 - 100 mm	20 / 25 mm	35 ÷ 60		0.25	0.20	0.15	0.13
	100 - 200 mm	20 / 25 mm	35 ÷ 60		0.25	0.20	0.15	0.13
200 - 300 mm	25 mm	35 ÷ 60	0.25	0.20	0.15	0.13		
Latón Brass	<10 mm	10 / 15 mm	30 ÷ 50	0.05 ÷ 0.10	0.20	0.15	0.12	0.13
	10 - 50 mm	15 / 20 mm	35 ÷ 55		0.25	0.20	0.18	0.15
		25 mm	40 ÷ 65		0.30	0.25	0.20	0.18
	50 - 100 mm	20 / 25 mm	40 ÷ 65		0.30	0.25	0.20	0.18
	100 - 200 mm	20 / 25 mm	40 ÷ 65		0.30	0.25	0.20	0.18
200 - 300 mm	25 mm	40 ÷ 65	0.30	0.25	0.20	0.18		

Valores recomendados / Recommended values





# MOLETEADO POR CORTE · VELOCIDADES DE CORTE Y AVANCES

## CUT-KNURLING · FEED AND SPEED



Material Material	Ø Pieza Ø Piece	Ø Moleta Ø Knurl	VC (m/min) VC (m/min)	Avance radial (mm/rev) Radial feed (mm/rev) (R)	Avance axial (mm/rev) Axial feed (mm/rev) (F)			
					Paso (mm) Pitch (mm)			
					0.3 + 0.6	0.6 + 1.2	1.2 + 1.6	1.6 + 2.0
Acero 600 N/mm <sup>2</sup> 600 N/mm <sup>2</sup> steel	<10 mm	8.9 mm	30 ÷ 50	0.05 ÷ 0.10	0.15	0.10	0.08	0.05
	10 - 50 mm	14.5 / 21.5 mm	35 ÷ 55		0.20	0.15	0.13	0.10
		21.5 mm	40 ÷ 60		0.25	0.20	0.15	0.12
	50 - 100 mm	21.5 mm	40 ÷ 60		0.25	0.20	0.15	0.12
	100 - 200 mm	21.5 mm	40 ÷ 60		0.25	0.20	0.15	0.12
200 - 300 mm	35 / 42 mm	60 ÷ 80	60 ÷ 80	0.30	0.25	0.20	0.15	
Acero 900 N/mm <sup>2</sup> 900 N/mm <sup>2</sup> steel	<10 mm	8.9 mm	15 ÷ 30	0.04 ÷ 0.08	0.12	0.08	0.05	0.04
	10 - 50 mm	14.5 / 21.5 mm	20 ÷ 40		0.15	0.10	0.08	0.06
		21.5 mm	25 ÷ 45		0.20	0.15	0.10	0.08
	50 - 100 mm	21.5 mm	25 ÷ 45		0.20	0.15	0.10	0.08
	100 - 200 mm	21.5 mm	25 ÷ 45		0.20	0.15	0.10	0.08
200 - 300 mm	35 / 42 mm	35 ÷ 55	35 ÷ 55	0.20	0.15	0.10	0.08	
Acero inoxidable Stainless steel	<10 mm	8.9 mm	15 ÷ 30	0.04 ÷ 0.08	0.12	0.08	0.05	0.04
	10 - 50 mm	14.5 / 21.5 mm	20 ÷ 40		0.15	0.10	0.08	0.06
		21.5 mm	25 ÷ 45		0.20	0.15	0.10	0.08
	50 - 100 mm	21.5 mm	25 ÷ 45		0.20	0.15	0.10	0.08
	100 - 200 mm	21.5 mm	25 ÷ 45		0.20	0.15	0.10	0.08
200 - 300 mm	35 / 42 mm	35 ÷ 55	35 ÷ 55	0.20	0.15	0.10	0.08	
Acero fundido Cast steel	<10 mm	8.9 mm	30 ÷ 50	0.05 ÷ 0.10	0.15	0.10	0.08	0.05
	10 - 50 mm	14.5 / 21.5 mm	35 ÷ 55		0.20	0.15	0.13	0.10
		21.5 mm	40 ÷ 60		0.25	0.20	0.15	0.12
	50 - 100 mm	21.5 mm	40 ÷ 60		0.25	0.20	0.15	0.12
	100 - 200 mm	21.5 mm	40 ÷ 60		0.25	0.20	0.15	0.12
200 - 300 mm	35 / 42 mm	60 ÷ 80	60 ÷ 80	0.30	0.25	0.20	0.15	
Aluminio Aluminium	<10 mm	8.9 mm	50 ÷ 70	0.05 ÷ 0.10	0.15	0.10	0.05	0.05
	10 - 50 mm	14.5 / 21.5 mm	55 ÷ 75		0.20	0.15	0.13	0.10
		21.5 mm	60 ÷ 90		0.25	0.20	0.15	0.12
	50 - 100 mm	21.5 mm	60 ÷ 90		0.25	0.20	0.15	0.12
	100 - 200 mm	21.5 mm	60 ÷ 90		0.25	0.20	0.15	0.12
200 - 300 mm	35 / 42 mm	80 ÷ 110	80 ÷ 110	0.30	0.25	0.20	0.15	
Latón Brass	<10 mm	8.9 mm	35 ÷ 55	0.05 ÷ 0.10	0.15	0.10	0.12	0.05
	10 - 50 mm	14.5 / 21.5 mm	40 ÷ 60		0.20	0.15	0.13	0.10
		21.5 mm	45 ÷ 65		0.25	0.20	0.15	0.12
	50 - 100 mm	21.5 mm	45 ÷ 65		0.25	0.20	0.15	0.12
	100 - 200 mm	21.5 mm	45 ÷ 65		0.25	0.20	0.15	0.12
200 - 300 mm	35 / 42 mm	70 ÷ 90	70 ÷ 90	0.30	0.25	0.20	0.15	

Valores recomendados / Recommended values



# INCREMENTO DEL Ø DE LA PIEZA MOLETEADA POR DEFORMACIÓN INCREASE OF Ø OF THE KNURLED PART BY FORM KNURLING



Material Material	Paso (mm) Pitch (mm)											
	Tipo Type	0.3	0.4	0.5	0.6	0.8	1.0	1.2	1.4	1.6	1.8	2.0
Acero de 90 kg 90 kg steel	RAA	0.08	0.13	0.18	0.22	0.36	0.43	0.50	0.58	0.66	0.68	0.96
	RBL	0.08	0.13	0.21	0.24	0.33	0.43	0.52	0.65	0.70	0.76	0.87
	RBR	0.08	0.13	0.21	0.24	0.33	0.43	0.52	0.65	0.70	0.76	0.87
	RGE	0.10	0.18	0.17	0.30	0.38	0.51	0.63	0.70	0.83	0.93	0.95
Acero de 60 kg 60 kg steel	RAA	0.08	0.15	0.20	0.24	0.38	0.45	0.52	0.60	0.68	0.70	0.98
	RBL	0.10	0.15	0.23	0.26	0.35	0.45	0.54	0.67	0.72	0.78	0.90
	RBR	0.10	0.15	0.23	0.26	0.35	0.45	0.54	0.67	0.72	0.78	0.90
	RGE	0.12	0.20	0.29	0.32	0.40	0.53	0.65	0.73	0.85	0.95	0.98
Acero inoxidable Stainless steel	RAA	0.10	0.14	0.20	0.25	0.33	0.45	0.50	0.60	0.70	0.80	0.90
	RBL	0.12	0.20	0.23	0.29	0.40	0.50	0.60	0.70	0.78	0.88	0.98
	RBR	0.12	0.20	0.23	0.29	0.40	0.50	0.60	0.70	0.78	0.88	0.98
	RGE	0.10	0.14	0.20	0.25	0.33	0.53	0.52	0.65	0.70	0.75	0.80
Aluminio Aluminium	RAA	0.10	0.15	0.20	0.25	0.33	0.45	0.50	0.58	0.65	0.79	0.85
	RBL	0.12	0.17	0.24	0.27	0.39	0.49	0.57	0.58	0.65	0.80	0.95
	RBR	0.12	0.17	0.24	0.27	0.39	0.49	0.57	0.58	0.65	0.80	0.95
	RGE	0.11	0.15	0.22	0.25	0.33	0.45	0.53	0.65	0.70	0.74	0.90
Latón Brass	RAA	0.10	0.15	0.20	0.25	0.30	0.35	0.42	0.45	0.50	0.52	0.56
	RBL	0.10	0.15	0.20	0.23	0.30	0.40	0.45	0.53	0.59	0.63	0.68
	RBR	0.10	0.15	0.20	0.23	0.30	0.40	0.45	0.53	0.59	0.63	0.68
	RGE	0.12	0.17	0.20	0.23	0.30	0.38	0.40	0.46	0.50	0.60	0.65

\* Valores aproximados / Approximate values



## RELACIÓN ENTRE EL DIÁMETRO A MOLETEAR Y EL PASO RELATIONSHIP BETWEEN PART DIAMETER AND PITCH



La relación entre el diámetro de la pieza a molear y el paso de la moleta seleccionada es muy importante para poder lograr un moleteado de calidad. Siempre hay que tratar de conseguir que la longitud de la circunferencia de la pieza a molear sea múltiplo del paso de la moleta utilizada.

The ratio between the diameter of the piece to be knurled and the pitch of the knurl is very important to achieve good quality knurling. The length of the circumference of the piece should always be a multiple of the knurl pitch used.

### EJEMPLO 1

Diámetro previo de la pieza: 21 mm  
Paso de la moleta: 1.0 mm  
Relación:  $21 \times 3.1416 / 1.0 = 65.97$   
Diferencia con número entero:  $66 - 65.97 = 0.03$

### EXAMPLE 1

Previous diameter of the workpiece: 21 mm  
Pitch of the knurl: 1.0 mm  
Ratio:  $21 \times 3.1416 / 1.0 = 65.97$   
Difference with whole number:  $66 - 65.97 = 0.03$

Cuanta mayor diferencia haya entre el valor obtenido del cálculo anterior y un número entero, mayor esfuerzo tendrá que realizar el conjunto moleteador-moleta para tratar de compensar la desproporción. Ese sobreesfuerzo se traduce en un moleteado de peor calidad y una reducción en el rendimiento de la moleta.

The greater the difference between the value obtained from the above calculation and a whole number, the more effort the tool will have to do to try to compensate the disproportion. This over-pressure generates a reduction in the quality of the knurling and in the performance of the knurl.

En el peor de los casos, cuando el valor de esa proporción difiere demasiado de un valor entero, se produce "doble moleteado". En este supuesto, el conjunto moleteador-moleta no logra compensar la desproporción y durante las primeras la moleta hace múltiples penetraciones en la pieza sin respetar el paso.

In the worst case, when the value of this proportion differs too much of a whole value, it makes a "double knurling". In this case, the knurling-knurl set cannot compensate for the disproportion and during the first turns the knurl makes multiple penetrations into the part without respecting the pitch.

### EJEMPLO 2

Diámetro previo de la pieza: 18 mm  
Paso de la moleta: 1.0 mm  
Relación:  $18 \times 3.1416 / 1.0 = 56.56$   
Diferencia con número entero:  $57 - 56.56 = 0.44$

### EXAMPLE 2

Previous diameter of the workpiece: 18 mm  
Pitch of the knurl: 1.0 mm  
Ratio:  $18 \times 3.1416 / 1.0 = 56.56$   
Difference with whole number:  $57 - 56.56 = 0.44$

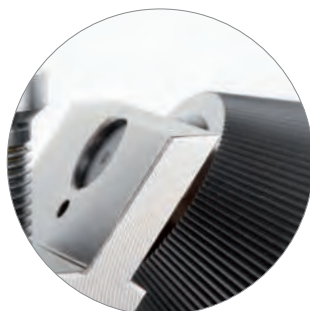
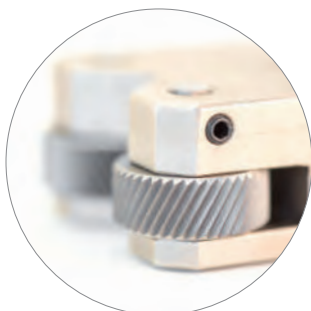

# MOLETEADO EN PIEZA SEGÚN DIN 82

## KNURLING ON COMPONENTS ACCORDING TO DIN 82



### RAA

Moletado con estrías paralelas al eje  
Knurling with grooves parallel to axis

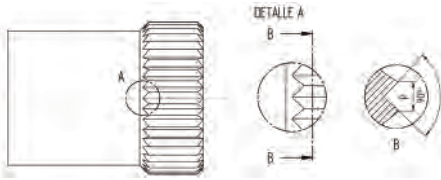

#### Moletado por deformación Form knurling

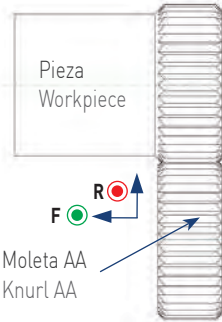

#### Moletado por corte Cut-knurling

Herramienta versión derecha  
Right hand tool



Herramienta versión izquierda  
Left hand tool

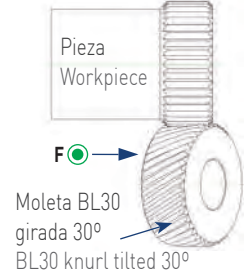

### RBL

Moletado con estrías en hélice hacia la izquierda  
Knurling with left spiral grooves

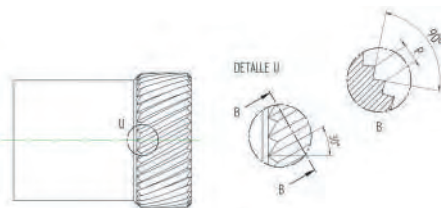

#### Moletado por deformación Form knurling

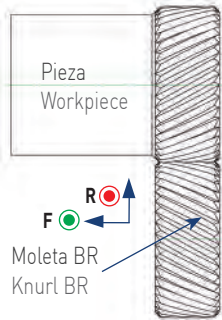

#### Moletado por corte Cut-knurling

Herramienta versión izquierda  
Left hand tool

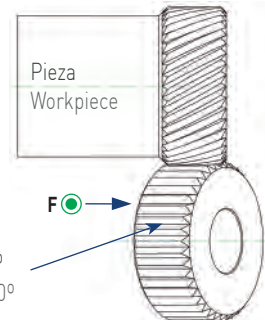

### RBR

Moletado con estrías en hélice hacia la derecha  
Knurling with right spiral grooves

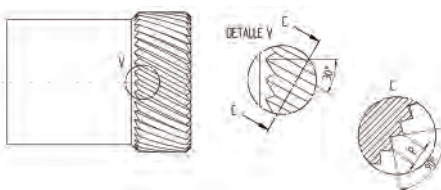

#### Moletado por deformación Form knurling

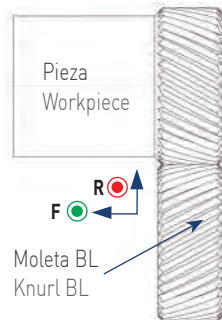

#### Moletado por corte Cut-knurling

Herramienta versión derecha  
Right hand tool

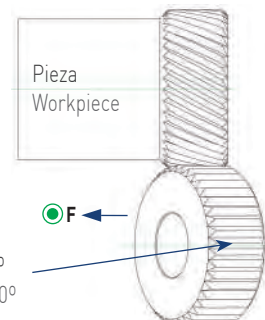

### RGE

Moletado con estrías cruzadas derecha-izquierda  
puntas salientes  
Knurling with left-right crossed grooves points up (male)

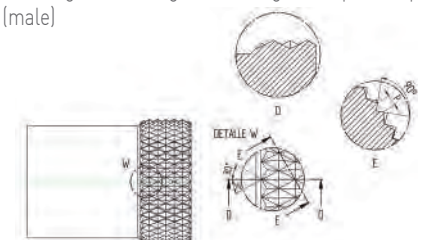

#### Moletado por deformación Form knurling

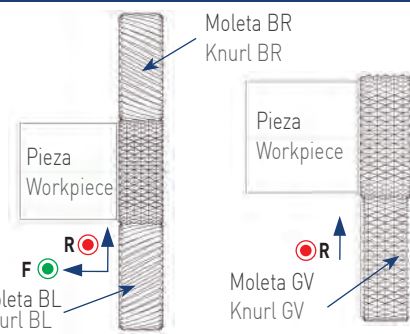

#### Moletado por corte Cut-knurling

Herramienta versión drcha. o versión izq.  
Right hand or left hand tool

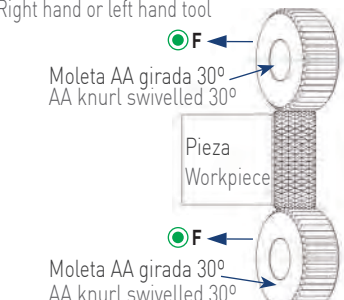

\* Avances permitidos / Allowed feeds  $\bullet$   $\bullet$   $\bullet$



# MOLETEADO EN PIEZA SEGÚN DIN 82 KNURLING ON COMPONENTS ACCORDING TO DIN 82



## RGV

Moleteado con estrías cruzadas derecha-izquierda puntas entrantes  
Knurling with left-right crossed grooves points down (female)

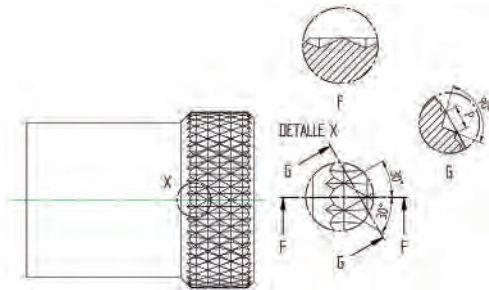

### Moleteado por deformación Form knurling

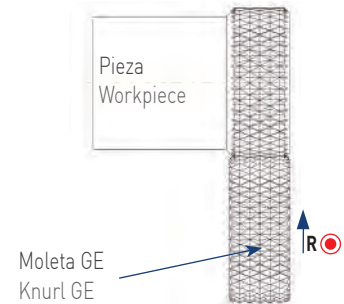

## RKE

Moleteado con estrías cruzadas en cuadrado puntas salientes  
Knurling with square crossed grooves points up (male)

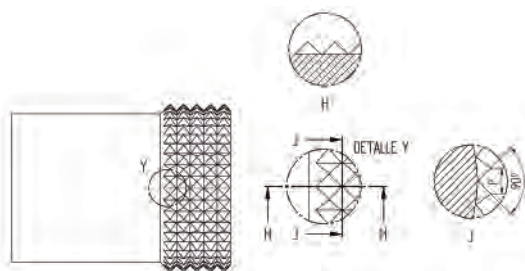

### Moleteado por deformación Form knurling

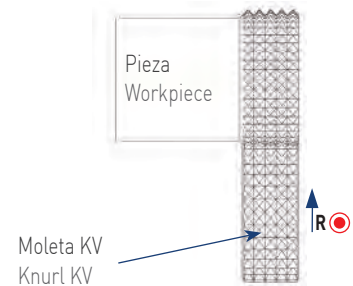

## RKV

Moleteado con estrías cruzadas en cuadrado puntas entrantes  
Knurling with square crossed grooves points down (female)

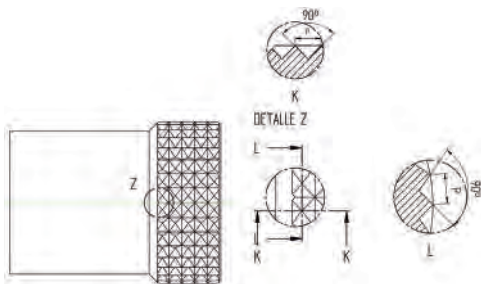

### Moleteado por deformación Form knurling

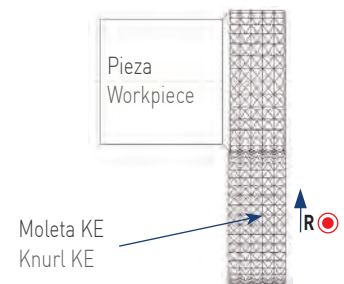

\* Avances permitidos / Allowed feeds **F** **R**



# GAMA MOLETAS INTEGI

## INTEGI KNURL RANGE

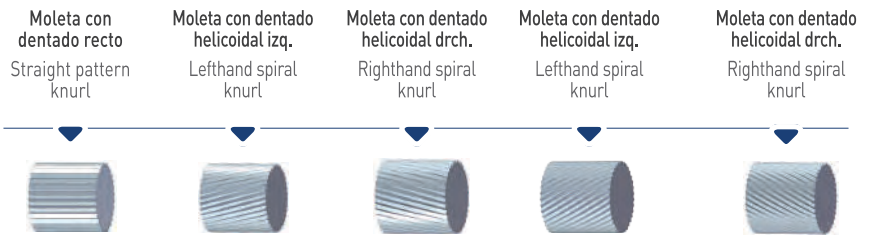

			MOLETAS PARA MOLETEADORES DE INTEGI				
			DIENTES FRESADOS				
			AA	BL15	BR15	BL30	BR30
MOLETAS DE DEFORMACION / FORM KNURLS	Dimensiones Sizes	Bisel Bevel					
	10x4x4	F	●			●	●
	10x5x4	F	●			●	●
	15x4x4	F	●			●	●
	15x5x4	F	●			●	●
	15x6x4	F	●			●	●
	15x6x10/6	F	●			●	●
	20x6x6	F	●			●	●
	20x8x6	F	●			●	●
	20x10x6	F	●			●	●
	25x8x8	F	●			●	●
	25x10x8	F	●			●	●
	25x12x8	F	●			●	●
25x10x15	F	●			●	●	
MOLETAS DE CORTE CUT KNURLS	8.9x2.5x4	S	●	●	●	●	●
	14.5x3x5	S	●	●	●	●	●
	21.5x5x8	S	●	●	●	●	●
	32x8x14	S	●	●	●	●	●
	42x12x18	S	●	●	●	●	●
			MOLETAS PARA MOLETEADORES PARA OTROS FABRICANTES				
			AA	BL15	BR15	BL30	BR30
MOLETAS DE DEFORMACION FORM KNURLS	Dimensiones Sizes	Bisel Bevel					
	15x6x11/6	F	●			●	●
	20x8x13/6	F	●			●	●
	20x6x6,5	F	●			●	●
	20x8x6,5	F	●			●	●
	20x10x6,5	F	●			●	●
	25x6x6	F	●			●	●
	25x8x6	F	●			●	●
25x10x6	F	●			●	●	
MOLETAS DE CORTE CUT KNURLS	15x4x8	S	●			●	●
	20x5x11	S	●			●	●
	25x5x11	S	●			●	●
	25x6x8	S	●			●	●

### Pasos disponibles · Available pitches

●	0.3 - 0.4 - 0.5 - 0.6 - 0.7 - 0.8 - 1.0 mm	●	0.4 - 0.5 - 0.6 - 0.7 - 0.8 - 1.0 - 1.2 - 1.5 - 1.6 - 1.8 - 2.0 mm
●	0.3 - 0.4 - 0.5 - 0.6 - 0.7 - 0.8 - 1.0 - 1.2 mm	●	1.0 - 1.5 - 2.0 - 2.5 - 3.0 mm
●	0.3 - 0.4 - 0.5 - 0.6 - 0.7 - 0.8 - 1.0 - 1.2 - 1.5 mm	●	1.0 - 1.5 - 2.0 - 2.5 - 3.0 - 3.5 - 4.0 mm

Otros pasos bajo pedido / Other pitches under request





# GAMA MOLETAS INTEG I INTEGI KNURL RANGE

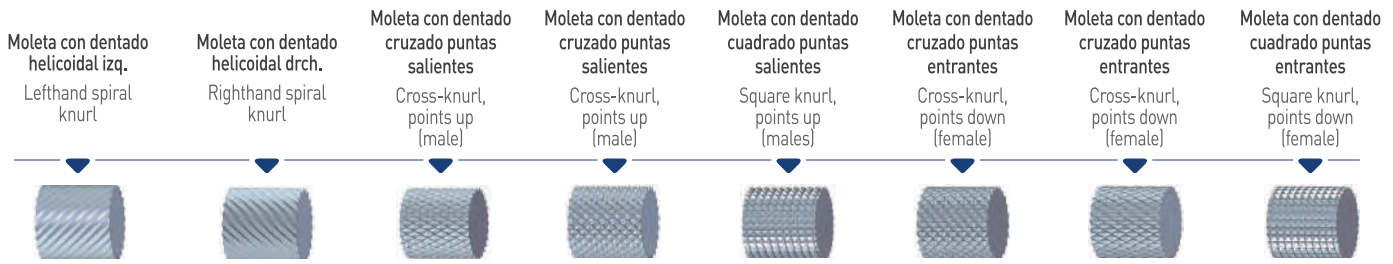

## / KNURLS FOR INTEG I KNURLING TOOLS

/ MILLED TEETH					DIENTES CONFORMADOS / FORMED TEETH		
BL45	BR45	GE30	GE45	KE	GV30	GV45	KV
●	●	●	●	●	●	●	●
●	●	●	●	●	●	●	●
●	●	●	●	●	●	●	●
●	●	●	●	●	●	●	●
●	●	●	●	●	●	●	●
●	●	●	●	●	●	●	●
●	●	●	●	●	●	●	●
●	●	●	●	●	●	●	●
●	●	●	●	●	●	●	●
●	●	●	●	●	●	●	●
●	●	●	●	●	●	●	●
●	●	●	●	●	●	●	●
●	●	●	●	●	●	●	●
●	●	●	●	●	●	●	●
●	●	●	●	●	●	●	●

## / KNURLS FOR KNURLING TOOL FOR OTHER MANUFACTURES

BL45	BR45	GE30	GE45	KE	GV30	GV45	KV
●	●	●	●	●	●	●	●
●	●	●	●	●	●	●	●
●	●	●	●	●	●	●	●
●	●	●	●	●	●	●	●
●	●	●	●	●	●	●	●
●	●	●	●	●	●	●	●
●	●	●	●	●	●	●	●
●	●	●	●	●	●	●	●
●	●	●	●	●	●	●	●
●	●	●	●	●	●	●	●
●	●	●	●	●	●	●	●
●	●	●	●	●	●	●	●
●	●	●	●	●	●	●	●
●	●	●	●	●	●	●	●
●	●	●	●	●	●	●	●

RECUBRIMIENTO COATING	DESCRIPCIÓN DESCRIPTION
TiN	Titanium Nitride PVD
TiCN	Titanium Carbon Nitride PVD
TiAlN	Titanium Aluminum Nitride PVD
AlCrN	Aluminum Chromium Nitride PVD
Nitried (Tenifer)	Nitried (Tenifer)

Tipo de bisel · Type of bevel	
F	Bisel en ambas caras (Moleta de deformación) · Bevel on both faces
S	Sin bisel (Moleta de corte) · Unbeveled





# MOLETAS ESPECIALES SPECIAL KNURLS



## + Moletas cónicas Conical knurls



### ▶ Datos necesarios para la fabricación de moletas cónicas:

- Tipo (KAA, KBL, ...)
- Ángulo de la hélice 30°, 45°
- Dimensiones
- Paso o número de dientes

### ▶ Necessary data to manufacture conical knurls:

- Type (KAA, KBL, ...)
- Helix angle 30°, 45°
- Dimensions
- Pitch or number of teeth

## + Moletas cóncavas y convexas Concave and convex knurls



### ▶ Datos necesarios para la fabricación de moletas cóncavas y convexas:

- Tipo (C, DL, ...)
- Ángulo de la hélice 30°, 45°
- Dimensiones
- Radio
- Paso o número de dientes

### ▶ Necessary data to manufacture concave and convex knurls:

- Type (C, DL, ...)
- Helix angle 30°, 45°
- Dimensions
- Radius
- Pitch or number of teeth

## + Moletas escalonadas Stepped knurls

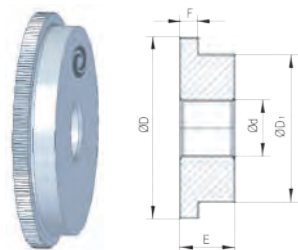

**Moleta escalonada (una cara)**  
Stepped knurl (one side)

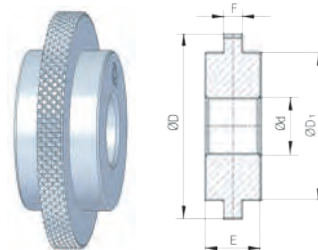

**Moleta escalonada (dos caras)**  
Stepped knurl (two sides)

### ▶ Datos para la fabricación de moletas especiales:

- Tipo (AA, BL, ...)
- Ángulo de la hélice
- Dimensiones
- Paso

### ▶ Necessary data to manufacture special knurls:

- Type (AA, BL, ...)
- Helix angle 30°, 45°
- Dimensions
- Pitch

# MOLETEADO KNURLING



# MOLETEADORES POR DEFORMACIÓN FORM-KNURLING TOOLS



M1

## Características

- Recomendado para moleteados tipo RAA
- Para trabajos no repetitivos
- Eje de HSS fijado mediante circlip

## Tipos de máquinas

- Para tornos convencionales

## Features

- Recommended for RAA type knurling
- For non-repetitive works
- HSS pin fixed by circlip

## Machine Types

- For conventional lathes

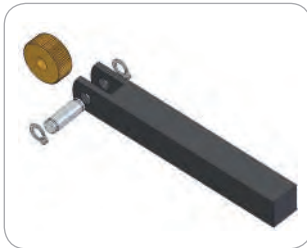

## Avance Feed

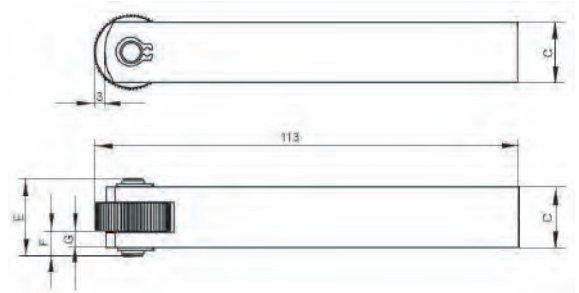
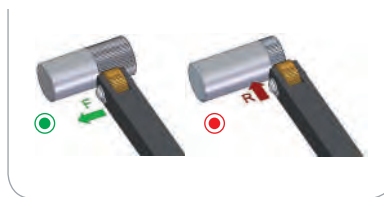

## Formas de moleteados realizables Feasible knurling forms

	RAA	RBL 30°	RBL 45°	RBR 30°	RBR 45°	RGE 30°	RGE 45°	RGV 30°	RGV 45°	RKE	RKV
Tipo de moleteado Knurling form											
Con moleta tipo With knurl type	AA	BR 30°	BR 45°	BL 30°	BL 45°	GV 30°	GV 45°	GE 30°	GE 45°	KV	KE
Avances permitidos Allowed feeds	F ● R ●	F ● R ●	F ● R ●	F ● R ●	F ● R ●	R ●	R ●	R ●	R ●	R ●	R ●

**R** Moleteados recomendados | Recommended knurling

Herramienta   Tool									
Código Code	Referencia Reference	Versión Version	Capacidad Capacity	Moleta Knurl	C	E	F	G	Kg Kg
01010100	M1 20.08.14	R+L	Ø 8-200	20x8x6	14	19	6	3	0.2
01010200	M1 20.08.16	R+L	Ø 8-200	20x8x6	16	21	6.5	4	0.2

Repuesto   Spare Part		
Código Code	Referencia Reference	
01990100	EM1	
01990007	EM1-16	



# MOLETEADORES POR DEFORMACIÓN FORM-KNURLING TOOLS



## M2

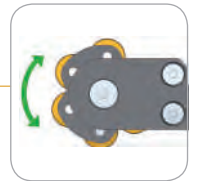

(Fig. 1)

### + Características

- Recomendado para moleteados tipo RGE
- Cabeza giratoria para el auto-centrado de las moletas (Fig. 1)
- Para trabajos no repetitivos
- Ejes de HSS

### Tipos de máquinas

- Para tornos convencionales

### + Features

- Recommended for RGE type knurling
- Revolving head for knurls self-centering (Fig. 1)
- For non-repetitive works
- HSS pins

### Machine Types

- For conventional lathes



### + Avance Feed

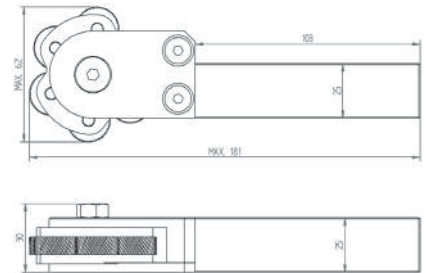

### + Formas de moleteados realizables Feasible knurling forms

	RAA	RGE 30°	RGE 45°
Tipo de moleteado Knurling form			
Con moleta tipo With knurl type	AA+AA	BL30° + BR30°	BL45° + BR45°
Avances permitidos Allowed feeds	F ● R ●	F ● R ●	F ● R ●

**R** Moleteados recomendados | Recommended knurling

Herramienta   Tool					
Código Code	Referencia Reference	Versión Version	Capacidad Capacity	Moleta Knurl	Kg Kg
01020100	M2 20.08.25	R+L	Ø 8-200	20x8x6	1.0

Repuesto   Spare Part		
Código Code	Referencia Reference	
01990201	EM2-SET	



# MOLETEADORES POR DEFORMACIÓN FORM-KNURLING TOOLS



## M3

### + Características

- Recomendado para moleteados tipo RGE
- Ajuste y centrado de las moletas sobre la pieza mediante husillo roscado
- Doble posición de los brazos para mayor capacidad de trabajo (Fig. 1)
- Menor riesgo de flexión de la pieza al no ejercer presión radial
- Apta para trabajos no repetitivos
- Ejes de HSS fijados mediante circlip

### Tipos de máquinas

- Para tornos convencionales

### + Features

- Recommended for RGE type knurling
- Knurls self-centering by threaded spindle
- Double position of the arms for higher working capacity (Fig. 1)
- Lower risk of bending the workpiece as tool does not make radial pressure
- Suitable for non-repetitive works
- HSS pins fixed by circlip

### Machine Types

- For conventional lathes

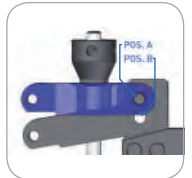

(Fig. 1)



### + Avance Feed

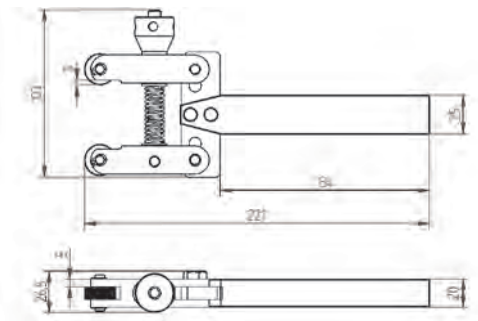

### + Formas de moleteados realizables Feasible knurling forms

	RAA	RGE 30°	RGE 45°
Tipo de moleteado Knurling form			
Con moleta tipo With knurl type	AA+AA	BL30° + BR30°	BL45° + BR45°
Avances permitidos Allowed feeds	F ● R ●	F ● R ●	F ● R ●

**R** Moleteados recomendados | Recommended knurling

Herramienta   Tool					
Código Code	Referencia Reference	Versión Version	Capacidad Capacity	Moleta Knurl	Kg Kg
01030100	M3 20.08.25	R+L	Pos A: Ø 5-40 Pos B: Ø 30-50	20x8x6	1.2

Repuesto   Spare Part		
Código Code	Referencia Reference	
01992701	EM3/M7-SET	





# MOLETEADORES POR DEFORMACIÓN FORM-KNURLING TOOLS



## M7



(Fig. 1)

### + Características

- Recomendado para moleteados tipo RGE
- Cabeza basculante para el autocentrado de las moletas (Fig. 1)
- Para trabajos no repetitivos
- Ejes de HSS fijados mediante circlip

### Tipos de máquinas

- Para tornos convencionales y CNC

### + Features

- Recommended for RGE type knurling
- Pivoting head for knurls self-centering (Fig. 1)
- For non-repetitive works
- HSS pins fixed by circlip

### Machine Types

- For conventional and CNC lathes



### + Avance Feed

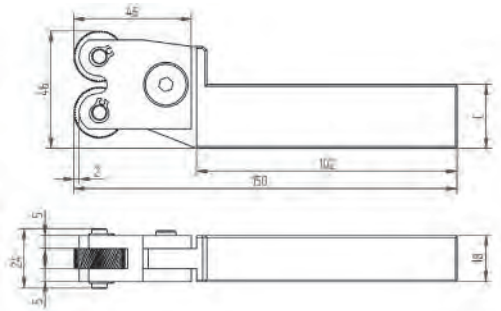

### + Formas de moleteados realizables Feasible knurling forms

	RAA	RGE 30°	RGE 45°
Tipo de moleteado Knurling form			
Con moleta tipo With knurl type	AA+AA	BL30° + BR30°	BL45° + BR45°
Avances permitidos Allowed feeds	F ● R ●	F ● R ●	F ● R ●

**R** Moleteados recomendados | Recommended knurling

Herramienta   Tool						
Código Code	Referencia Reference	Versión Version	Capacidad Capacity	Moleta Knurl	C	Kg Kg
01160200	M7N 20.08.20	R+L	Ø 8-200	20x8x6	20	0.7
01160300	M7N 20.08.25	R+L	Ø 8-200	20x8x6	25	0.7

Repuesto   Spare Part		
Código Code	Referencia Reference	
01992701	EM3/M7-SET	



## MOLETEADORES POR DEFORMACIÓN FORM-KNURLING TOOLS



### KM1-M7

#### + Características

- Conjunto b sico de moleteado
- Para trabajos no repetitivos

#### Contenido

- 1 x Herramienta modelo M1
- 1 x Herramienta modelo M7N
- 1 x Eje de repuesto para herramienta M1
- 2 x Eje de repuesto para herramienta M7N
- 1 x Moleta BL30 20x8x6 0.8
- 1 x Moleta BR30 20x8x6 0.8
- 1 x Moleta BL30 20x8x6 1.2
- 1 x Moleta BR30 20x8x6 1.2
- 1 x Moleta BL30 20x8x6 1.6
- 1 x Moleta BR30 20x8x6 1.6
- 1 x Moleta AA 20x8x6 0.8
- 1 x Moleta AA 20x8x6 1.2
- 1 x Moleta AA 20x8x6 1.6

#### + Features

- Basic knurling kit
- For non-repetitive works

#### Content

- 1 x Tool model M1
- 1 x Tool model M7N
- 1 x HSS pin for M1 tool
- 2 x HSS pin for M7N tool
- 1 x Knurl BL30 20x8x6 0.8
- 1 x Knurl BR30 20x8x6 0.8
- 1 x Knurl BL30 20x8x6 1.2
- 1 x Knurl BR30 20x8x6 1.2
- 1 x Knurl BL30 20x8x6 1.6
- 1 x Knurl BR30 20x8x6 1.6
- 1 x Knurl AA 20x8x6 0.8
- 1 x Knurl AA 20x8x6 1.2
- 1 x Knurl AA 20x8x6 1.6



Herramienta   Tool				
Código Code	Referencia Reference	Herramientas incluidas Included tools	Capacidad Capacity	Kg
01110100	KM1-14/M7	M1 20.08.14 + M7N 20.08.25	Ø 8-200	1,2
01110200	KM1-16/M7	M1 20.08.16 + M7N 20.08.25	Ø 8-200	1,2





# MOLETEADORES POR DEFORMACIÓN FORM-KNURLING TOOLS



## M6



### + Características

- Recomendado para moleteados tipo RAA
- Eje de metal duro
- Superficie endurecida para una mayor resistencia al desgaste
- Ajuste del ángulo de ataque mediante tornillos integrados en el mango

### + Features

- Recommended for RAA type knurling
- Carbide pin
- Anti-wearing treatment of the tool surface
- Adjustment of tool clearance angle by threaded studs integrated in the tool shank



### + Avance Feed

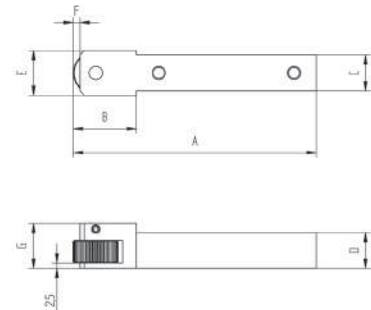

### + Formas de moleteados realizables Feasible knurling forms

	R RAA	RBL 30°	RBL 45°	RBR 30°	RBR 45°	RGE 30°	RGE 45°	RGV 30°	RGV 45°	RKE	RKV
Tipo de moleteado Knurling form											
Con moleta tipo With knurl type	AA	BR 30°	BR 45°	BL 30°	BL 45°	GV 30°	GV 45°	GE 30°	GE 45°	KV	KE
Avances permitidos Allowed feeds	F ● R ●	F ● R ●	F ● R ●	F ● R ●	F ● R ●	R ●	R ●	R ●	R ●	R ●	R ●

**R** Moleteados recomendados | Recommended knurling

Herramienta   Tool												
Código Code	Referencia Reference	Versión Version	Capacidad Capacity	Moleta Knurl	A	B	C	D	E	F	G	Kg Kg
01060300	M6 10.05.08	R+L	Ø 3-50	10x5x4	122	17	8	8	10	0,9	14	0,3
01060400	M6 10.05.10	R+L	Ø 3-50	10x5x4	122	17	10	10	10	0,9	14	0,3
01062800	M6 15.06.08-N	R+L	Ø 3-100	15x6x4	102,5	22,5	8	8	14	3,5	14	0,3
01062900	M6 15.06.10-N	R+L	Ø 3-100	15x6x4	102,5	22,5	10	10	14	3,5	14	0,3
01063000	M6 15.06.12-N	R+L	Ø 3-100	15x6x4	102,5	22,5	12	12	14	3,5	14	0,3
01063100	M6 15.06.14-N	R+L	Ø 3-100	15x6x4	102,5	22,5	14	14	14	3,5	14	0,3
01061300	M6 20.06.10	R+L	Ø 5-200	20x6x6	108	28	10	10	20	3	20	0,3
01061400	M6 20.06.12	R+L	Ø 5-200	20x6x6	108	28	12	12	20	3	20	0,3
01061500	M6 20.06.14	R+L	Ø 5-200	20x6x6	108	28	14	14	20	3	20	0,3
01061600	M6 20.06.16	R+L	Ø 5-200	20x6x6	108	28	16	16	20	3	20	0,4
01061700	M6 20.06.20	R+L	Ø 5-200	20x6x6	108	28	20	20	20	3	20	0,5
01061800	M6 20.08.10	R+L	Ø 5-200	20x8x6	108	28	10	10	20	3	20	0,3
01061900	M6 20.08.12	R+L	Ø 5-200	20x8x6	108	28	12	12	20	3	20	0,3
01062000	M6 20.08.14	R+L	Ø 5-200	20x8x6	108	28	14	14	20	3	20	0,3
01062100	M6 20.08.16	R+L	Ø 5-200	20x8x6	108	28	16	16	20	3	20	0,4
01062200	M6 20.08.20	R+L	Ø 5-200	20x8x6	108	28	20	20	20	3	20	0,5
01062300	M6 20.10.10	R+L	Ø 5-200	20x10x6	108	28	10	10	20	3	20	0,3
01062400	M6 20.10.12	R+L	Ø 5-200	20x10x6	108	28	12	12	20	3	20	0,3
01062500	M6 20.10.14	R+L	Ø 5-200	20x10x6	108	28	14	14	20	3	20	0,3
01062600	M6 20.10.16	R+L	Ø 5-200	20x10x6	108	28	16	16	20	3	20	0,4
01062700	M6 20.10.20	R+L	Ø 5-200	20x10x6	108	28	20	20	20	3	20	0,5

Repuesto   Spare Part	
Código Code	Referencia Reference
01990301	E 14.4 HM
01990601	E 20.6 HM



# MOLETEADORES POR DEFORMACIÓN FORM-KNURLING TOOLS



## M8



### + Características

- Recomendado para moleteados tipo RAA
- Eje de metal duro
- Superficie endurecida para una mayor resistencia al desgaste
- Ajuste del ángulo de ataque mediante tornillos integrados en el mango

### + Features

- Recommended for RAA type knurling
- Carbide pin
- Anti-wearing treatment of the tool surface
- Adjustment of tool clearance angle by threaded studs integrated in the shank



### + Avance Feed

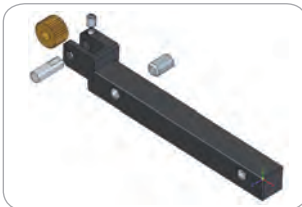

### + Formas de moleteados realizables Feasible knurling forms

	RAA	RBL 30°	RBL 45°	RBR 30°	RBR 45°	RGE 30°	RGE 45°	RGV 30°	RGV 45°	RKE	RKV
Tipo de moleteado Knurling form											
Con moleta tipo With knurl type	AA	BR 30°	BR 45°	BL 30°	BL 45°	GV 30°	GV 45°	GE 30°	GE 45°	KV	KE
Avances permitidos Allowed feeds	F ● R ●	F ● R ●	F ● R ●	F ● R ●	F ● R ●	R ●	R ●	R ●	R ●	R ●	R ●

**R** Moleteados recomendados | Recommended knurling

Herramienta   Tool										
Código Code	Referencia Reference	Versión Version	Capacidad Capacity	Moleta Knurl	A Ø10/Ø15	B Ø10/Ø15	C	D Ø10/Ø15	E Ø10/Ø15	Kg Kg
01200100	M8 15.04.08 R	R	Ø 3-50 / Ø 3-100	10x4x4 / 15x4x4	96.5 / 99	16.5 / 19	8	2 / 4.5	15 / 17.5	0.2
01200200	M8 15.04.08 L	L	Ø 3-50 / Ø 3-100	10x4x4 / 15x4x4	96.5 / 99	16.5 / 19	8	2 / 4.5	15 / 17.5	0.2
01200700	M8 15.05.08 R	R	Ø 3-50 / Ø 3-100	10x5x4 / 15x5x4	96.5 / 99	16.5 / 19	8	2 / 4.5	15 / 17.5	0.2
01200800	M8 15.05.08 L	L	Ø 3-50 / Ø 3-100	10x5x4 / 15x5x4	96.5 / 99	16.5 / 19	8	2 / 4.5	15 / 17.5	0.2
01201300	M8 15.06.08 R	R	Ø 3-100	15x6x4	99	19	8	4.5	17.5	0.2
01201400	M8 15.06.08 L	L	Ø 3-100	15x6x4	99	19	8	4.5	17.5	0.2
01200300	M8 15.04.10 R	R	Ø 3-50 / Ø 3-100	10x4x4 / 15x4x4	96.5 / 99	16.5 / 19	10	2 / 4.5	15 / 17.5	0.2
01200400	M8 15.04.10 L	L	Ø 3-50 / Ø 3-100	10x4x4 / 15x4x4	96.5 / 99	16.5 / 19	10	2 / 4.5	15 / 17.5	0.2
01200900	M8 15.05.10 R	R	Ø 3-50 / Ø 3-100	10x5x4 / 15x5x4	96.5 / 99	16.5 / 19	10	2 / 4.5	15 / 17.5	0.2
01201000	M8 15.05.10 L	L	Ø 3-50 / Ø 3-100	10x5x4 / 15x5x4	96.5 / 99	16.5 / 19	10	2 / 4.5	15 / 17.5	0.2
01201500	M8 15.06.10 R	R	Ø 3-100	15x6x4	99	19	10	4.5	17.5	0.2
01201600	M8 15.06.10 L	L	Ø 3-100	15x6x4	99	19	10	4.5	17.5	0.2
01200500	M8 15.04.12 R	R	Ø 3-50 / Ø 3-100	10x4x4 / 15x4x4	96.5 / 99	16.5 / 19	12	2 / 4.5	15 / 17.5	0.2
01200600	M8 15.04.12 L	L	Ø 3-50 / Ø 3-100	10x4x4 / 15x4x4	96.5 / 99	16.5 / 19	12	2 / 4.5	15 / 17.5	0.2
01201100	M8 15.05.12 R	R	Ø 3-50 / Ø 3-100	10x5x4 / 15x5x4	96.5 / 99	16.5 / 19	12	2 / 4.5	15 / 17.5	0.2
01201200	M8 15.05.12 L	L	Ø 3-50 / Ø 3-100	10x5x4 / 15x5x4	96.5 / 99	16.5 / 19	12	2 / 4.5	15 / 17.5	0.2
01201700	M8 15.06.12 R	R	Ø 3-100	15x6x4	99	19	12	4.5	17.5	0.2
01201800	M8 15.06.12 L	L	Ø 3-100	15x6x4	99	19	12	4.5	17.5	0.2
01201900	M8 15.04.16 R	R	Ø 3-50 / Ø 3-100	10x4x4 / 15x4x4	96.5 / 99	16.5 / 19	16	2 / 4.5	15 / 17.5	0.2
01202000	M8 15.04.16 L	L	Ø 3-50 / Ø 3-100	10x4x4 / 15x4x4	96.5 / 99	16.5 / 19	16	2 / 4.5	15 / 17.5	0.2
01202100	M8 15.05.16 R	R	Ø 3-50 / Ø 3-100	10x5x4 / 15x5x4	96.5 / 99	16.5 / 19	16	2 / 4.5	15 / 17.5	0.2
01202200	M8 15.05.16 L	L	Ø 3-50 / Ø 3-100	10x5x4 / 15x5x4	96.5 / 99	16.5 / 19	16	2 / 4.5	15 / 17.5	0.2
01202300	M8 15.06.16 R	R	Ø 3-100	15x6x4	99	19	16	4.5	17.5	0.2
01202400	M8 15.06.16 L	L	Ø 3-100	15x6x4	99	19	16	4.5	17.5	0.2

Repuesto   Spare Part	
Código Code	Referencia Reference
01989701	E 12.4 HM
01982200	E 16.4 HM

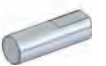



# MOLETEADORES POR DEFORMACIÓN FORM-KNURLING TOOLS



## M20

### + Características

- Recomendado para moleteados tipo RAA
- Para moleteados hasta una cara lateral (Fig.1)
- Eje de HSS
- Superficie endurecida para una mayor resistencia al desgaste
- Ajuste del ángulo de ataque mediante tornillos integrados en el mango

### + Features

- Recommended for RAA type knurling
- For knurling up to a shoulder (Fig.1)
- HSS bushing
- Anti-wearing treatment of the tool surface
- Adjustment of tool clearance angle by threaded studs integrated in the shank



(Fig. 1)

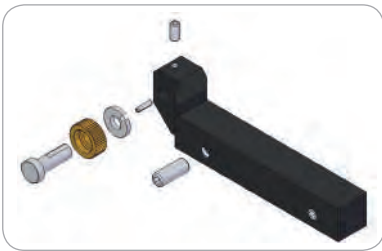

### + Avance Feed

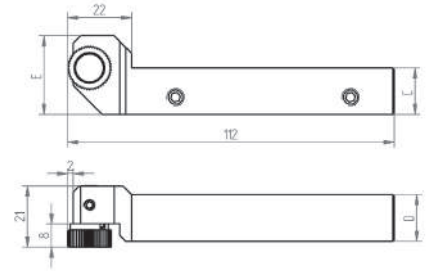
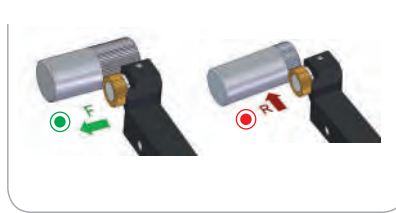

### + Formas de moleteados realizables Feasible knurling forms

	RAA	RBL 30°	RBL 45°	RBR 30°	RBR 45°	RGE 30°	RGE 45°	RGV 30°	RGV 45°	RKE	RKV
Tipo de moleteado Knurling form											
Con moleta tipo With knurl type	AA	BR 30°	BR 45°	BL 30°	BL 45°	GV 30°	GV 45°	GE 30°	GE 45°	KV	KE
Avances permitidos Allowed feeds	F ● R ●	F ● R ●	F ● R ●	F ● R ●	F ● R ●	R ●	R ●	R ●	R ●	R ●	R ●

### R Moleteados recomendados | Recommended knurling

Herramienta   Tool							
Código Code	Referencia Reference	Versión Version	Capacidad Capacity	Moleta Knurl	C	D	Kg Kg
01290300	M20 15.06.10 R	R	∅ 3-100	15x6x10/6	10	10	0.3
01290400	M20 15.06.10 L	L	∅ 3-100	15x6x10/6	10	10	0.3
01290500	M20 15.06.12 R	R	∅ 3-100	15x6x10/6	12	16	0.3
01290600	M20 15.06.12 L	L	∅ 3-100	15x6x10/6	12	16	0.3
01290700	M20 15.06.16 R	R	∅ 3-100	15x6x10/6	16	16	0.3
01290800	M20 15.06.16 L	L	∅ 3-100	15x6x10/6	16	16	0.3

Repuesto   Spare Part	
Código Code	Referencia Reference
01983220	EAM20/M21



# MOLETEADORES POR DEFORMACIÓN FORM-KNURLING TOOLS



M4

## + Características

- Recomendado para moleteados tipo RAA
- Eje de metal duro
- Superficie endurecida para una mayor resistencia al desgaste
- Ajuste del ángulo de ataque mediante tornillos integrados en el mango

## + Features

- Recommended for RAA type knurling
- Carbide pin
- Anti-wearing treatment of the tool surface
- Adjustment of tool clearance angle by threaded studs integrated in the shank

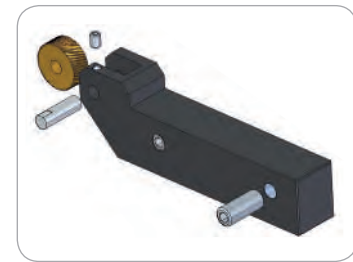

## + Avance Feed

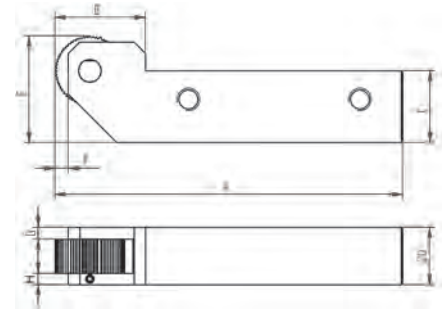
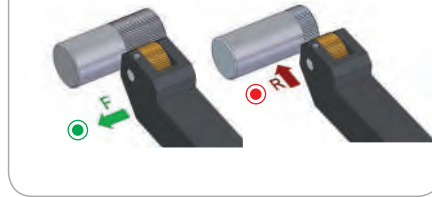

## + Formas de moleteados realizables Feasible knurling forms

	R	RAA	RBL 30°	RBL 45°	RBR 30°	RBR 45°	RGE 30°	RGE 45°	RGV 30°	RGV 45°	RKE	RKV
Tipo de moleteado Knurling form												
Con moleta tipo With knurl type		AA	BR 30°	BR 45°	BL 30°	BL 45°	GV 30°	GV 45°	GE 30°	GE 45°	KV	KE
Avances permitidos Allowed feeds		F ● R ●	F ● R ●	F ● R ●	F ● R ●	F ● R ●	R ●	R ●	R ●	R ●	R ●	R ●

R Moleteados recomendados | Recommended knurling

Herramienta   Tool													
Código Code	Referencia Reference	Versión Version	Capacidad Capacity	Moleta Knurl	A	B	C	D	E	F	G	H	Kg
01041200	M4 20.08.16	R+L	Ø 8-200	20x8x6	120	29,5	16	20	26	2,5	6	6	0,3
01041300	M4 20.08.20	R+L	Ø 8-200	20x8x6	120	29,5	20	20	30	2,5	6	6	0,4
01041400	M4 20.08.25	R+L	Ø 8-200	20x8x6	120	29,5	25	20	35	2,5	6	6	0,5
01041500	M4 20.10.20	R+L	Ø 8-200	20x10x6	120	29,5	20	20	30	2,5	5	5	0,4
01041600	M4 20.10.25	R+L	Ø 8-200	20x10x6	120	29,5	25	20	35	2,5	5	5	0,5
01041700	M4 25.08.20	R+L	Ø 8-300	25x8x8	122	32	20	20	32,5	5	6	6	0,4
01041800	M4 25.08.25	R+L	Ø 8-300	25x8x8	122	32	25	20	37,5	5	6	6	0,5
01041900	M4 25.10.20	R+L	Ø 8-300	25x10x8	122	32	20	20	32,5	5	5	5	0,4
01042000	M4 25.10.25	R+L	Ø 8-300	25x10x8	122	32	25	20	37,5	5	5	5	0,5
01042100	M4 25.12.20	R+L	Ø 8-300	25x12x8	122	32	20	25	32,5	5	5,5	7,5	0,6
01042200	M4 25.12.25	R+L	Ø 8-300	25x12x8	122	32	25	25	37,5	5	5,5	7,5	0,6

Repuesto   Spare Part	
Código Code	Referencia Reference
01990601	E 20.6 HM
01986001	E 20.8 HM
01992501	E 25.8 HM





# MOLETEADORES POR DEFORMACIÓN FORM-KNURLING TOOLS



## M10

### + Características

- Recomendado para moleteados tipo RAA
- Para moleteados hasta una cara lateral (Fig. 1)
- Eje de HSS
- Para trabajar a derechas o izquierdas (Fig. 2)
- Superficie endurecida para una mayor resistencia al desgaste
- Ajuste del ángulo de ataque mediante tornillos integrados en el mango
- Provista de arandela de HSS para prevenir el desgaste de la herramienta

### + Features

- Recommended for RAA type knurling
- For knurling up to a shoulder (Fig. 1)
- HSS bushing
- Able to fit on right-hand or left-hand (Fig. 2)
- Anti-wearing treatment of the tool surface
- Adjustment of tool clearance angle by threaded studs integrated in the shank
- Supplied with a HSS hardened washer to prevent tool wearing



(Fig. 1)



(Fig. 2)

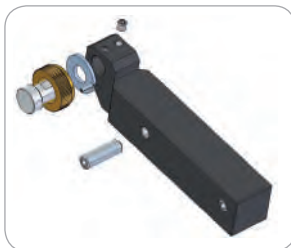

### + Avance Feed

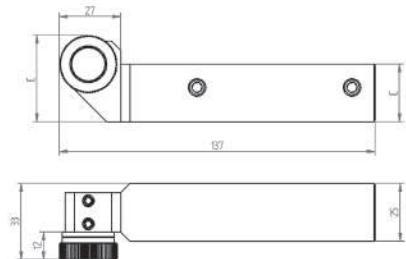
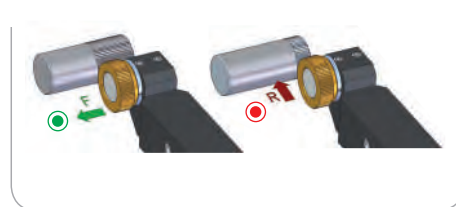

### + Formas de moleteados realizables Feasible knurling forms

	R	RAA	RBL 30°	RBL 45°	RBR 30°	RBR 45°	RGE 30°	RGE 45°	RGV 30°	RGV 45°	RKE	RKV
Tipo de moleteado Knurling form												
Con moleta tipo With knurl type		AA	BR 30°	BR 45°	BL 30°	BL 45°	GV 30°	GV 45°	GE 30°	GE 45°	KV	KE
Avances permitidos Allowed feeds		F ● R ●	F ● R ●	F ● R ●	F ● R ●	F ● R ●	R ●	R ●	R ●	R ●	R ●	R ●

R Moleteados recomendados | Recommended knurling

Herramienta   Tool							
Código Code	Referencia Reference	Versión Version	Capacidad Capacity	Moleta Knurl	C	E	Kg Kg
01070100	M10 25.10.20	R+L	∅ 8-200	25x10x15/11	20	30	0.7
01070200	M10 25.10.25	R+L	∅ 8-200	25x10x15/11	25	35	0.8

Repuesto   Spare Part		
Código Code	Referencia Reference	
01983200	EAM10	



# MOLETEADORES POR DEFORMACIÓN FORM-KNURLING TOOLS



M19

## + Características

- Recomendado para moleteados tipo RAA
- Para moleteado interior
- Eje de HSS
- Provista de arandela de HSS para evitar el desgaste de la herramienta

## + Features

- Recommended for RAA type knurling
- For internal knurling
- HSS bushing
- Supplied with a HSS hardened washer to prevent tool wearing



## + Avance Feed

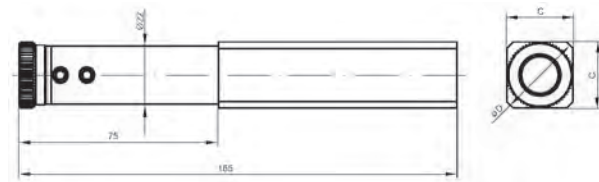
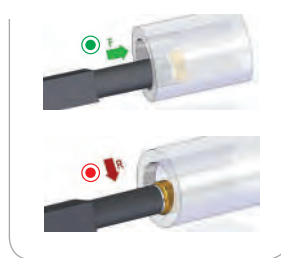

## + Formas de moleteados realizables Feasible knurling forms

	R	RAA	RBL 30°	RBL 45°	RBR 30°	RBR 45°	RGE 30°	RGE 45°	RGV 30°	RGV 45°	RKE	RKV
Tipo de moleteado Knurling form												
Con moleta tipo With knurl type		AA	BR 30°	BR 45°	BL 30°	BL 45°	GV 30°	GV 45°	GE 30°	GE 45°	KV	KE
Avances permitidos Allowed feeds		F ● R ●	F ● R ●	F ● R ●	F ● R ●	F ● R ●	R ●	R ●	R ●	R ●	R ●	R ●

R Moleteados recomendados | Recommended knurling

Herramienta   Tool							
Código Code	Referencia Reference	Versión Version	Capacidad Capacity	Moleta Knurl	C	D	Kg Kg
01190100	M19 25.10.20	R+L	∅ 30-200	25x10x15/11	20	25	0.7
01190200	M19 25.10.25	R+L	∅ 30-200	25x10x15/11	25	32	0.8

Repuesto   Spare Part		
Código Code	Referencia Reference	
01983200	EAM10	



# MOLETEADORES POR DEFORMACIÓN FORM-KNURLING TOOLS



## M15

### + Características

- Recomendado para moleteados tipo RKAA
- Para moleteado frontal o cónico
- Cabeza portamoletas giratoria (Fig. 1)
- Eje de metal duro

### + Features

- Recommended for RKAA type knurling
- For conical or face knurling
- Swivel tool head (Fig. 1)
- Carbide pin



(Fig. 1)

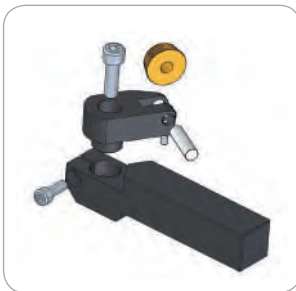

### + Avance Feed

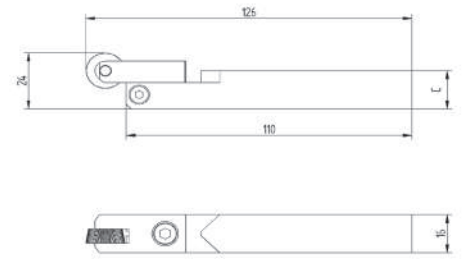

Modelo M15 15

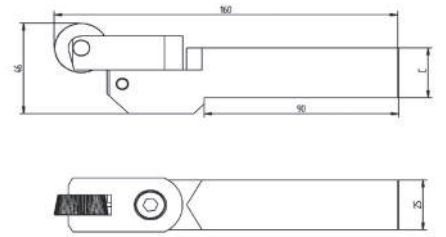

Modelo M15 25

### + Formas de moleteados realizables Feasible knurling forms

	<b>R</b> RKAA	RKBL 30°	RKBR 30°
Tipo de moleteado Knurling form			
Con moleta tipo With knurl type	KA	KBR 30°	KBL 30°
Avances permitidos Allowed feeds	<b>R</b>	<b>R</b>	<b>R</b>

**R** Moleteados recomendados | Recommended knurling

Herramienta   Tool						
Código Code	Referencia Reference	Versión Version	Capacidad Capacity	Moleta* Knurl*	C	Kg Kg
01150100	M15 15.06.12	R+L	Ø 3-100	15x6x4 (c nica/conical)	12	0,3
01150200	M15 15.06.16	R+L	Ø 3-100	15x6x4 (c nica/conical)	16	0,3
01150300	M15 25.08.20	R+L	Ø 8-300	25x8x8 (c nica/conical)	20	0,6
01150400	M15 25.08.25	R+L	Ø 8-300	25x8x8 (c nica/conical)	25	0,8
01150500	M15 25.10.20	R+L	Ø 8-300	25x10x8 (c nica/conical)	20	0,6
01150600	M15 25.10.25	R+L	Ø 8-300	25x10x8 (c nica/conical)	25	0,8
01150700	M15 25.12.20	R+L	Ø 8-300	25x12x8 (c nica/conical)	20	0,8
01150800	M15 25.12.25	R+L	Ø 8-300	25x12x8 (c nica/conical)	25	0,8

Repuesto   Spare Part	
Código Code	Referencia Reference
01982200	E 16.4 HM
01992501	E 25.8 HM



\*Dimensiones aproximadas / Approximate sizes



# MOLETEADORES POR DEFORMACIÓN FORM-KNURLING TOOLS



## M12

### + Características

- Recomendado para moleteados tipo RGE en piezas de pequeño diámetro
- Menor riesgo de flexión de la pieza al no ejercer presión radial
- Sistema de centrado para compensar un posible desalineamiento del torno (Fig. 2)
- Ajuste y centrado de las moletas sobre la pieza mediante husillo roscado (Fig. 1)
- Ejes de metal duro
- Superficie de los brazos endurecida para una mayor resistencia al desgaste
- Ajuste del ángulo de ataque mediante tornillos integrados en el mango

### + Features

- Recommended for RGE type knurling on small diameter workpieces
- Lower risk of bending the workpiece as tool does not make radial pressure
- Self-centering system to compensate a possible misalignment of the lathe turret (Fig. 2)
- Knurls self-centering by threaded spindle (Fig. 1)
- Carbide pins
- Anti-wearing treatment of the arms surface.
- Adjustment of tool clearance angle by threaded studs integrated in the shank



(Fig. 1)

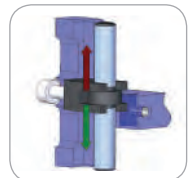

(Fig. 2)

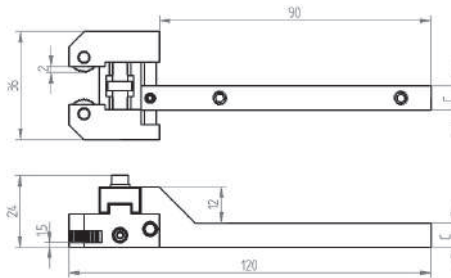

### + Avance Feed

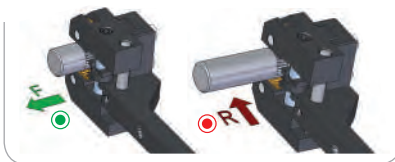

### + Formas de moleteados realizables Feasible knurling forms

	RAA	R RGE 30°	R RGE 45°
Tipo de moleteado Knurling form			
Con moleta tipo With knurl type	AA+AA	BL30° + BR30°	BL45° + BR45°
Avances permitidos Allowed feeds	F ● R ●	F ● R ●	F ● R ●

**R** Moleteados recomendados | Recommended knurling

#### Herramienta | Tool

Código Code	Referencia Reference	Versión Version	Capacidad Capacity	Moleta Knurl	C	Kg
01120700	M12 10.04.10 R	R	Ø 1-12	10x4x4	10	0.2
01120800	M12 10.04.10 L	L	Ø 1-12	10x4x4	10	0.2
01120900	M12 10.04.12 R	R	Ø 1-12	10x4x4	12	0.2
01121000	M12 10.04.12 L	L	Ø 1-12	10x4x4	12	0.2
01121100	M12 10.04.16 R	R	Ø 1-12	10x4x4	16	0.2
01121200	M12 10.04.16 L	L	Ø 1-12	10x4x4	16	0.2

#### Repuesto | Spare Part

Código Code	Referencia Reference
01989701	E 12.4 HM





# MOLETEADORES POR DEFORMACIÓN FORM-KNURLING TOOLS



## M9

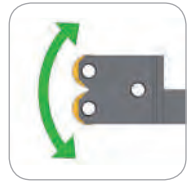

(Fig. 1)

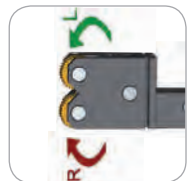

(Fig. 2)

### + Características

- Recomendado para moleteados tipo RGE
- Cabeza basculante para el autocentrado de las moletas sobre la pieza (Fig. 1)
- Cabeza reversible para trabajar a derechas o izquierdas (Fig. 2)
- Ejes de metal duro
- Superficie endurecida para una mayor resistencia al desgaste
- Ajuste del ángulo de ataque mediante tornillos integrados en el mango

### + Features

- Recommended for RGE type knurling
- Pivoting head for knurls self-centering (Fig. 1)
- Tool with reversible head able to fit on left-hand or right-hand lathes (Fig. 2)
- Carbide pins
- Anti-wearing treatment surface
- Adjustment of tool clearance angle by threaded studs integrated in the shank



### + Avance Feed

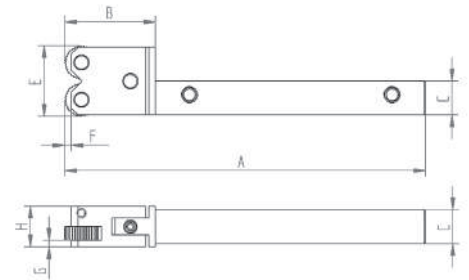

### + Formas de moleteados realizables Feasible knurling forms

	RAA	R RGE 30°	R RGE 45°
Tipo de moleteado Knurling form			
Con moleta tipo With knurl type	AA+AA	BL30° + BR30°	BL45° + BR45°
Avances permitidos Allowed feeds	F ● R ●	F ● R ●	F ● R ●

**R** Moleteados recomendados | Recommended knurling

Herramienta   Tool												
Código Code	Referencia Reference	Versión Version	Capacidad Capacity	Moleta Knurl	A	B	C	E	F	G	H	Kg Kg
01180100	M9 10.04.08	R+L	Ø 3-50	10x4x4	107	27	8	21	2	2	12	0.1
01180200	M9 10.04.10	R+L	Ø 3-50	10x4x4	107	27	10	21	2	2	12	0.1
01180300	M9 10.04.12	R+L	Ø 3-50	10x4x4	107	27	12	21	2	2	12	0.1
01180400	M9 15.04.16	R+L	Ø 5-100	15x4x4	130.5	40.5	16	32	1.5	3	16	0.1
01180500	M9 15.05.16	R+L	Ø 5-100	15x5x4	130.5	40.5	16	32	1.5	3	16	0.1
01180600	M9 15.06.16	R+L	Ø 5-100	15x6x4	130.5	40.5	16	32	1.5	3	16	0.1

Repuesto   Spare Part		
Código Code	Referencia Reference	
01989701	E 12.4 HM	
01982200	E 16.4 HM	

# MOLETEADORES POR DEFORMACIÓN FORM-KNURLING TOOLS



## M21

### + Características

- Recomendado para moleteados tipo RGE
- Para moleteados hasta una cara lateral (Fig. 1)
- Eje de HSS
- Superficie endurecida para una mayor resistencia al desgaste
- Ajuste del ángulo de ataque mediante tornillos integrados en el mango
- Provista de arandela de HSS para prevenir el desgaste de la herramienta

### + Features

- Recommended for RGE type knurling
- For knurling up to a shoulder (Fig. 1)
- HSS bushing
- Anti-wearing treatment of the tool surface
- Adjustment of tool clearance angle by threaded studs integrated in the shank
- Supplied with a HSS hardened washer to prevent tool wearing



(Fig. 1)

### + Avance Feed

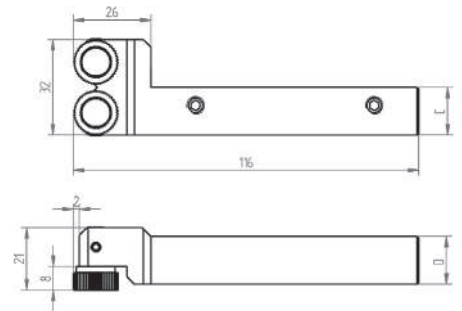

### + Formas de moleteados realizables Feasible knurling forms

	RAA	RGE 30°	RGE 45°
Tipo de moleteado Knurling form			
Con moleta tipo With knurl type	AA+AA	BL30° + BR30°	BL45° + BR45°
Avances permitidos Allowed feeds	F ● R ●	F ● R ●	F ● R ●

**R** Moleteados recomendados | Recommended knurling

Herramienta   Tool							
Código Code	Referencia Reference	Versión Version	Capacidad Capacity	Moleta Knurl	C	D	Kg Kg
01280300	M21 15.06.10 R	R	Ø 5-100	15x6x10/6	10	10	0.4
01280400	M21 15.06.10 L	L	Ø 5-100	15x6x10/6	10	10	0.4
01280500	M21 15.06.12 R	R	Ø 5-100	15x6x10/6	12	16	0.4
01280600	M21 15.06.12 L	L	Ø 5-100	15x6x10/6	12	16	0.4
01280700	M21 15.06.16 R	R	Ø 5-100	15x6x10/6	16	16	0.4
01280800	M21 15.06.16 L	L	Ø 5-100	15x6x10/6	16	16	0.4

Repuesto   Spare Part	
Código Code	Referencia Reference
01983220	EAM20/M21





# MOLETEADORES POR DEFORMACIÓN FORM-KNURLING TOOLS



## M5

### + Características

- Recomendado para moleteados tipo RGE
- Cabeza basculante para el autocentrado de las moletas sobre la pieza [Fig. 1]
- Cabeza reversible para trabajar a derechas o izquierdas [Fig. 2]
- Ejes de metal duro
- Superficie endurecida para una mayor resistencia al desgaste
- Ajuste del ángulo de ataque mediante tornillos integrados en el mango

### + Features

- Recommended for RGE type knurling
- Pivoting head for knurls self-centering [Fig. 1]
- Tool with reversible head able to fit on left-hand or right-hand lathes [Fig. 2]
- Carbide pins
- Anti-wearing treatment surface
- Adjustment of tool clearance angle by threaded studs integrated in the shank



[Fig. 1]

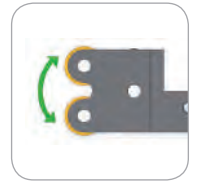

[Fig. 2]

### + Avance Feed

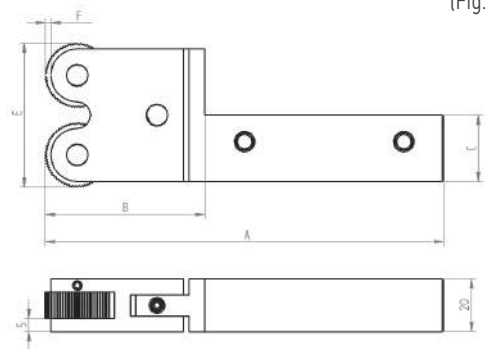

### + Formas de moleteados realizables Feasible knurling forms

	RAA	RGE 30°	RGE 45°
Tipo de moleteado Knurling form			
Con moleta tipo With knurl type	AA+AA	BL30° + BR30°	BL45° + BR45°
Avances permitidos Allowed feeds	F ● R ●	F ● R ●	F ● R ●

**R** Moleteados recomendados | Recommended knurling

Herramienta   Tool										
Código Code	Referencia Reference	Versión Version	Capacidad Capacity	Moleta Knurl	A	B	C	E	F	Kg Kg
01050700	M5 20.08.20	R+L	Ø 8-200	20x8x6	139,5	49	20	42	2.5	1.0
01050800	M5 20.08.25	R+L	Ø 8-200	20x8x6	139,5	49	25	42	2.5	1.0
01050900	M5 20.10.20	R+L	Ø 8-200	20x10x6	139,5	49	20	42	2.5	1.0
01051000	M5 20.10.25	R+L	Ø 8-200	20x10x6	139,5	49	25	42	2.5	1.0
01050100	M5 25.08.20	R+L	Ø 8-300	25x8x8	150	60	20	55	2.5	1.0
01050200	M5 25.08.25	R+L	Ø 8-300	25x8x8	150	60	25	55	2.5	1.0
01050300	M5 25.10.20	R+L	Ø 8-300	25x10x8	150	60	20	55	2.5	1.0
01050400	M5 25.10.25	R+L	Ø 8-300	25x10x8	150	60	25	55	2.5	1.0

Repuesto   Spare Part	
Código Code	Referencia Reference
01990601	E 20.6 HM
01986001	E 20.8 HM





# MOLETEADORES POR DEFORMACIÓN FORM-KNURLING TOOLS



## M11

### + Características

- Recomendado para moleteados tipo RGE
- Para moleteados hasta una cara lateral (Fig. 1)
- Cabeza basculante para el autocentrado de las moletas sobre la pieza (Fig. 2)
- Ejes de HSS
- Superficie endurecida para una mayor resistencia al desgaste
- Ajuste del ángulo de ataque mediante tornillos integrados en el mango

### + Features

- Recommended for RGE type knurling
- For knurling up to a shoulder (Fig. 1)
- Pivoting head for knurls self-centering (Fig. 2)
- HSS bushings
- Anti-wearing treatment of the tool surface
- Adjustment of tool clearance angle by threaded studs integrated in the shank

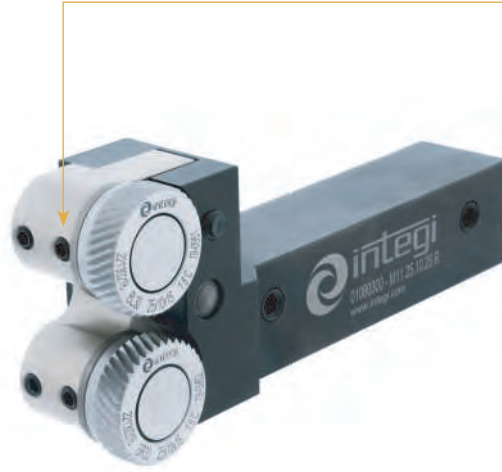

(Fig. 1)



(Fig. 2)

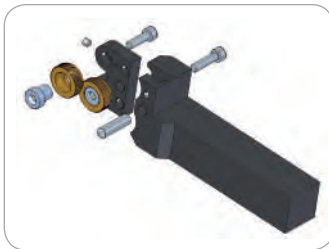

### + Avance Feed

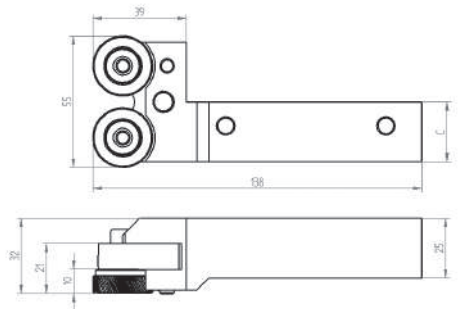

### + Formas de moleteados realizables Feasible knurling forms

	RAA	RGE 30°	RGE 45°
Tipo de moleteado Knurling form			
Con moleta tipo With knurl type	AA+AA	BL30° + BR30°	BL45° + BR45°
Avances permitidos Allowed feeds	F ● R ●	F ● R ●	F ● R ●

**R** Moleteados recomendados | Recommended knurling

Herramienta   Tool						
Código Code	Referencia Reference	Versión Version	Capacidad Capacity	Moleta Knurl	C	Kg Kg
01080100	M11 25.10.20 R	R	Ø 8-200	25x10x15/11	20	1.0
01080200	M11 25.10.20 L	L	Ø 8-200	25x10x15/11	20	1.0
01080300	M11 25.10.25 R	R	Ø 8-200	25x10x15/11	25	1.2
01080400	M11 25.10.25 L	L	Ø 8-200	25x10x15/11	25	1.2

Repuesto   Spare Part		
Código Code	Referencia Reference	
01983200	EAM10	





# MOLETEADORES POR DEFORMACIÓN FORM-KNURLING TOOLS



## M16

### + Características

- Recomendado para moleteados tipo RKA
- Especial para moleteado según DIN-72783
- Menor riesgo de flexión de la pieza al no ejercer presión radial
- Sistema de centrado para compensar un posible desalineamiento del torno (Fig. 1)
- Ajuste y centrado de las moletas sobre la pieza mediante husillo roscado (Fig. 2)
- Ejes de metal duro
- Provista de arandelas de HSS para evitar el desgaste de los brazos portamoletas

### + Features

- Recommended for RKA type knurling
- Specially designed for knurling according to DIN-72783
- Lower risk of bending the workpiece as tool does not make radial pressure
- Self-centering system to compensate a possible misalignment of the lathe turret (Fig. 1)
- Knurls self-centering by threaded spindle (Fig. 2)
- Carbide pins
- Supplied with HSS hardened washers to prevent arms wearing

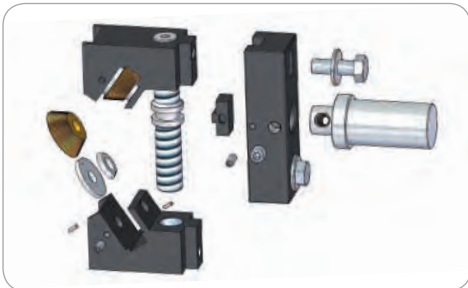

### + Avance Feed

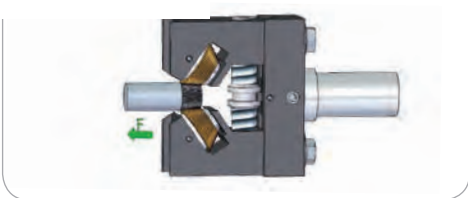

(Fig. 1)



(Fig. 2)

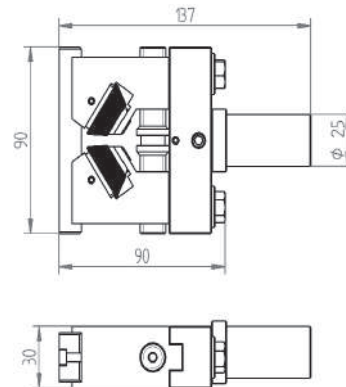

### + Formas de moleteados realizables Feasible knurling forms

	RKAA	RKGE 30°	RKGE 45°
Tipo de moleteado Knurling form			
Con moleta tipo With knurl type	KA + KAA	KBL30° + KBR30°	KBL45° + KBR45°
Avances permitidos Allowed feeds	F	F	F

**R** Moleteados recomendados | Recommended knurling

Herramienta   Tool					
Código Code	Referencia Reference	Versión Version	Capacidad Capacity	Moleta Knurl	Kg Kg
01210100	M16	R+L	∅ 1 - 12	Cónica Conical	1.5

Repuesto   Spare Part		
Código Code	Referencia Reference	
01981700	EM16 HM	



# MOLETEADORES POR DEFORMACIÓN FORM-KNURLING TOOLS



## M22-A

### + Características

- Recomendado para moleteados tipo RGE en piezas de pequeño diámetro
- Menor riesgo de flexión de la pieza al no ejercer presión radial
- Sistema de centrado para compensar un posible desalineamiento del torno (Fig. 1)
- Ajuste y centrado de las moletas sobre la pieza mediante husillo roscado (Fig. 2)
- Ejes de metal duro
- Superficie de los brazos endurecida para una mayor resistencia al desgaste

### + Features

- Recommended for RGE type knurling on small diameter workpieces
- Lower risk of bending the workpiece as tool does not make radial pressure
- Self-centering system to compensate a possible misalignment of the lathe turret (Fig. 1)
- Knurls self-centering by threaded spindle (Fig. 2)
- Carbide pins
- Anti-wearing treatment of the arms surface



(Fig. 1)



(Fig. 2)

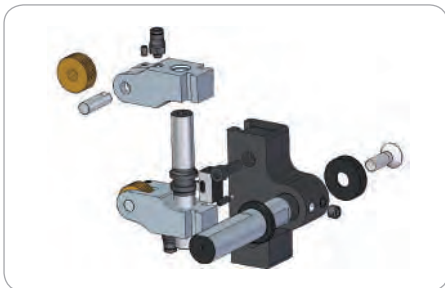
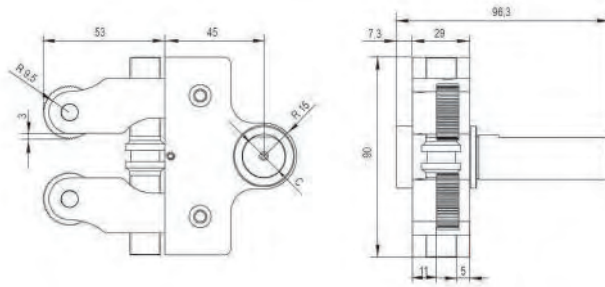

### + Avance Feed



### + Formas de moleteados realizables Feasible knurling forms

	RAA	RGE 30°	RGE 45°
Tipo de moleteado Knurling form			
Con moleta tipo With knurt type	AA+AA	BL30° + BR30°	BL45° + BR45°
Avances permitidos Allowed feeds	F <input checked="" type="radio"/> R <input type="radio"/>	F <input checked="" type="radio"/> R <input type="radio"/>	F <input checked="" type="radio"/> R <input type="radio"/>

**R** Moleteados recomendados | Recommended knurling

Herramienta   Tool						
Código Code	Referencia Reference	Versión Version	Capacidad Capacity	Moleta Knurl	C	Kg
01300100	M22 D19.05-A	R+L	Ø 6-50 mm	25x10x8	19.05	1.7
01300200	M22 D20-A	R+L	Ø 6-50 mm	25x10x8	20	1.7
01300300	M22 D22-A	R+L	Ø 6-50 mm	25x10x8	22	1.7
01300400	M22 D25-A	R+L	Ø 6-50 mm	25x10x8	25	1.7
01300500	M22 D25.4-A	R+L	Ø 6-50 mm	25x10x8	25.4	1.7

Repuesto   Spare Part	
Código Code	Referencia Reference
01990800	E 26.8 HM







# MOLETEADORES POR DEFORMACIÓN FORM-KNURLING TOOLS



## M22-B

### + Características

- Recomendado para moleteados tipo RGE en piezas de pequeño diámetro
- Menor riesgo de flexión de la pieza al no ejercer presión radial
- Sistema de centrado para compensar un posible desalineamiento del torno (Fig. 1)
- Ajuste y centrado de las moletas sobre la pieza mediante husillo roscado (Fig. 2)
- Superficie de los brazos endurecida para una mayor resistencia al desgaste
- Para moleteados hasta una cara lateral (Fig.3)

### + Features

- Recommended for RGE type knurling on small diameter workpieces
- Lower risk of bending the workpiece as tool does not make radial pressure
- Self-centering system to compensate a possible misalignment of the lathe turret (Fig. 1)
- Knurls self-centering by threaded spindle (Fig. 2)
- Anti-wearing treatment of the arms surface
- For knurling up to a shoulder (Fig.3)

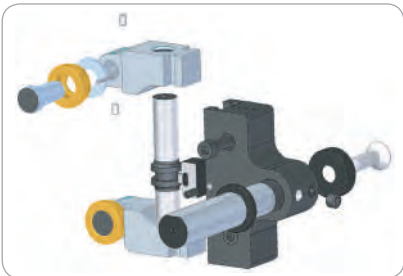

### + Avance Feed

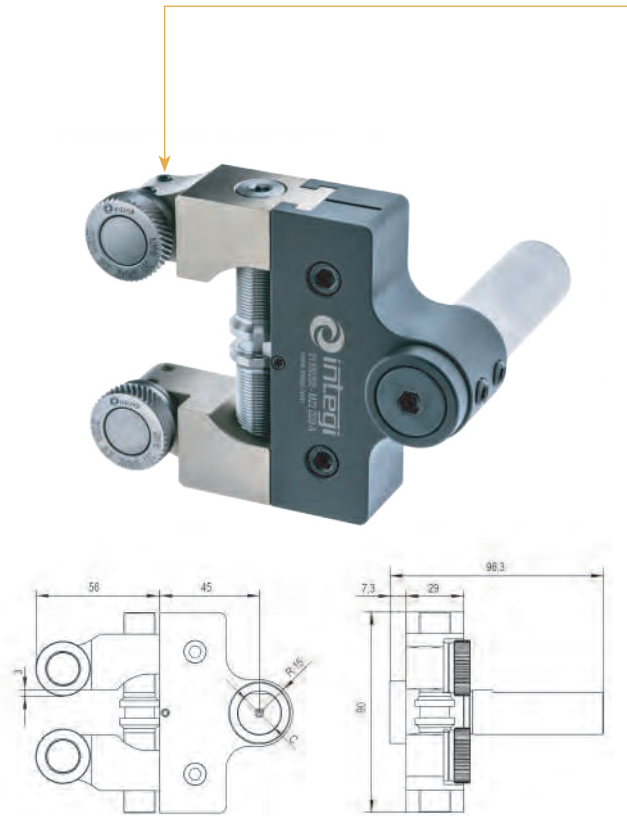
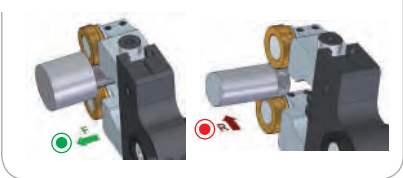

(Fig. 1)



(Fig. 2)

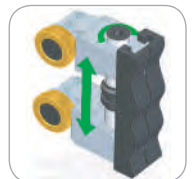

(Fig. 3)

### + Formas de moleteados realizables Feasible knurling forms

	RAA	R RGE 30°	R RGE 45°
Tipo de moleteado Knurling form			
Con moleta tipo With knurl type	AA+AA	BL30° + BR30°	BL45° + BR45°
Avances permitidos Allowed feeds	F ● R ●	F ● R ●	F ● R ●

**R** Moleteados recomendados | Recommended knurling

#### Herramienta | Tool

Código Code	Referencia Reference	Versión Version	Capacidad Capacity	Moleta Knurl	C	Kg
01300101	M22 D19.05-B	R+L	Ø 6-50 mm	25x10x15/11	19.05	1.7
01300201	M22 D20-B	R+L	Ø 6-50 mm	25x10x15/11	20	1.7
01300301	M22 D22-B	R+L	Ø 6-50 mm	25x10x15/11	22	1.7
01300401	M22 D25-B	R+L	Ø 6-50 mm	25x10x15/11	25	1.7
01300501	M22 D25.4-B	R+L	Ø 6-50 mm	25x10x15/11	25.4	1.7

#### Repuesto | Spare Part

Código Code	Referencia Reference	
01983200	EAM10	

# MOLETEADORES POR DEFORMACIÓN FORM-KNURLING TOOLS



## M23-A

### + Características

- Recomendado para moleteados tipo RGE en piezas de pequeño diámetro
- Menor riesgo de flexión de la pieza al no ejercer presión radial
- Sistema de centrado para compensar un posible desalineamiento del torno [Fig. 1]
- Ajuste y centrado de las moletas sobre la pieza mediante husillo roscado [Fig. 2]
- Ejes de metal duro
- Superficie de los brazos endurecida para una mayor resistencia al desgaste

### + Features

- Recommended for RGE type knurling on small diameter workpieces
- Lower risk of bending the workpiece as tool does not make radial pressure
- Self-centering system to compensate a possible misalignment of the lathe turret [Fig. 1]
- Knurls self-centering by threaded spindle [Fig. 2]
- Carbide pins
- Anti-wearing treatment of the arms surface



(Fig. 1)



(Fig. 2)

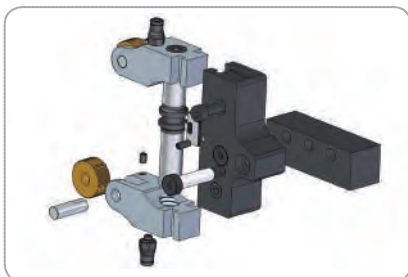
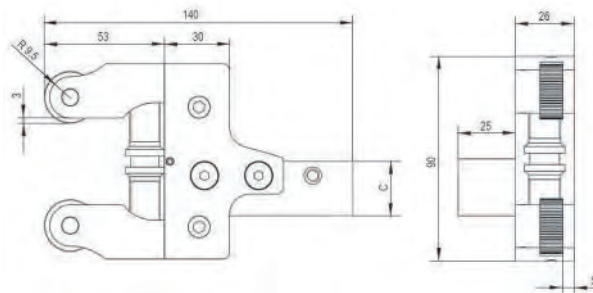

### + Avance Feed

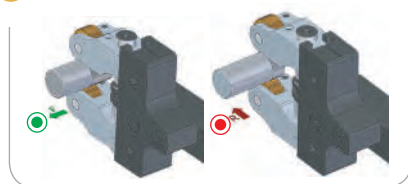

### + Formas de moleteados realizables Feasible knurling forms

	RAA	<sup>R</sup> RGE 30°	<sup>R</sup> RGE 45°
Tipo de moleteado Knurling form			
Con moleta tipo With knurl type	AA+AA	BL30° + BR30°	BL45° + BR45°
Avances permitidos Allowed feeds	F <input checked="" type="radio"/> R <input checked="" type="radio"/>	F <input checked="" type="radio"/> R <input checked="" type="radio"/>	F <input checked="" type="radio"/> R <input checked="" type="radio"/>

<sup>R</sup> Moleteados recomendados | Recommended knurling

Herramienta   Tool						
Código Code	Referencia Reference	Versión Version	Capacidad Capacity	Moleta Knurl	C	Kg
01310100	M23 20 R-A	R	Ø 6-50	25x10x8	20	1.7
01310200	M23 20 L-A	L	Ø 6-50	25x10x8	20	1.7
01310300	M23 25 R-A	R	Ø 6-50	25x10x8	25	1.7
01310400	M23 25 L-A	L	Ø 6-50	25x10x8	25	1.7

Repuesto   Spare Part	
Código Code	Referencia Reference
01990800	E 26.8 HM





# MOLETEADORES POR DEFORMACIÓN FORM-KNURLING TOOLS



## M23-B

### + Características

- Recomendado para moleteados tipo RGE en piezas de pequeño diámetro
- Menor riesgo de flexión de la pieza al no ejercer presión radial
- Sistema de centrado para compensar un posible desalineamiento del torno (Fig. 1)
- Ajuste y centrado de las moletas sobre la pieza mediante husillo roscado (Fig. 2)
- Superficie de los brazos endurecida para una mayor resistencia al desgaste
- Con brazos modelo B para moleteados hasta una cara. (Fig. 3)

### + Features

- Recommended for RGE type knurling on small diameter workpieces
- Lower risk of bending the workpiece as tool does not make radial pressure
- Self-centering system to compensate a possible misalignment of the lathe turret (Fig. 1)
- Knurls self-centering by threaded spindle (Fig. 2)
- Anti-wearing treatment of the arms surface
- With B type arms for knurling up to a shoulder (Fig. 3)



### + Avance Feed

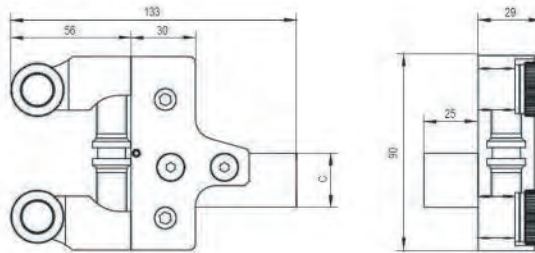
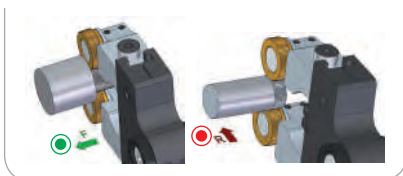

[Fig. 1]



[Fig. 2]

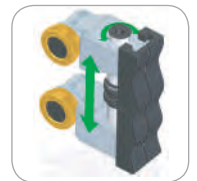

[Fig. 3]

### + Formas de moleteados realizables Feasible knurling forms

	RAA	<sup>R</sup> RGE 30°	<sup>R</sup> RGE 45°
Tipo de moleteado Knurling form			
Con moleta tipo With knurl type	AA+AA	BL30° + BR30°	BL45° + BR45°
Avances permitidos Allowed feeds	F ● R ●	F ● R ●	F ● R ●

<sup>R</sup> Moleteados recomendados | Recommended knurling

Herramienta   Tool						
Código Code	Referencia Reference	Versión Version	Capacidad Capacity	Moleta Knurl	C	Kg
01310101	M23 20 R-B	R	Ø 6-50	25x10x15/11	20	1.7
01310201	M23 20 L-B	L	Ø 6-50	25x10x15/11	20	1.7
01310301	M23 25 R-B	R	Ø 6-50	25x10x15/11	25	1.7
01310401	M23 25 L-B	L	Ø 6-50	25x10x15/11	25	1.7

Repuesto   Spare Part		
Código Code	Referencia Reference	
01983200	EAM10	



# MOLETEADORES POR DEFORMACIÓN FORM-KNURLING TOOLS



## M17 10 / M17 20



(Fig. 1)

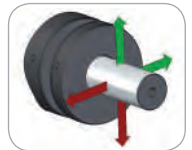

(Fig. 2)

### + Características

- Recomendado para moleteados tipo RAA y RGE
- Ataque frontal mediante 3 garras de ajuste simultaneo (Fig. 1)
- Sistema de centrado para compensar un posible desalineamiento del torno (Fig. 2)
- Ejes de metal duro
- Superficie endurecida para una mayor resistencia al desgaste

### + Features

- Recommended for RAA and RGE type knurling
- Frontal feeding by means of 3 jaws simultaneously adjusted (Fig. 1)
- Self-centering system to compensate a possible misalignment of the lathe turret (Fig. 2)
- Carbide pins
- Anti-wearing treatment of the tool surface



### + Avance Feed

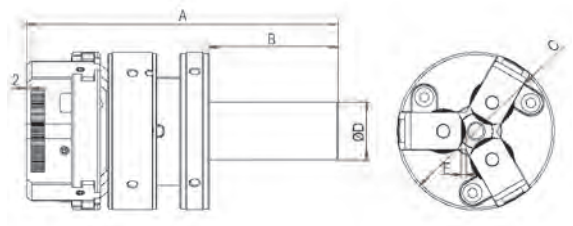

LONGITUD MÁXIMA DE MOLETEADO (mm) MAXIMUM KNURLING LENGTH (mm)		
Modelo Model	Ø Pieza Piece Ø	Longitud (mm) Length (mm)
M17 10	<10	40
	<14	69
M17 20	>14<21	37
	>21<30	17

### + Formas de moleteados realizables Feasible knurling forms

	RAA	RGE 30°	RGE 45°
Tipo de moleteado Knurling form			
Con moleta tipo With knurl type	AA+AA+AA	BL30° + BR30° + BR30°	BL45° + BR45° + BR45°
Avances permitidos Allowed feeds	F	F	F

**R** Moleteados recomendados | Recommended knurlings

Herramienta   Tool									
Código Code	Referencia Reference	Capacidad Capacity	Moleta Knurl	A	B	C	D	E	Kg
01170300	M17 10.04.1/2"	Ø 3-10 mm	10x4x4	107	57,5	44	12,7	1,5	1,0
01170100	M17 10.04.16	Ø 3-10 mm	10x4x4	107	57,5	44	16	1,5	1,0
01170500	M17 20.06.3/4"	Ø 5-30 mm	20x6x6	139	57,5	70	19,05	2,0	1,4
01170200	M17 20.06.20	Ø 5-30 mm	20x6x6	139	57,5	70	20	2,0	1,4
01170600	M17 20.06.22	Ø 5-30 mm	20x6x6	139	57,5	70	22	2,0	1,5
01170700	M17 20.06.25	Ø 5-30 mm	20x6x6	139	57,5	70	25	2,0	1,5
01170400	M17 20.06.1"	Ø 5-30 mm	20x6x6	139	57,5	70	25,4	2,0	1,5

Repuesto   Spare Part	
Código Code	Referencia Reference
01981800	EM17 10.04 HM
01998201	EM17 20.06 HM







# MOLETEADORES POR DEFORMACIÓN FORM-KNURLING TOOLS



## M17 15 / M17 25

### + Características

- Recomendado para moleteados tipo RAA y RGE
- Ataque frontal mediante 3 garras de ajuste simultaneo (Fig. 1)
- Sistema de centrado para compensar un posible desalineamiento del torno (Fig. 2)
- Ejes de metal duro
- Superficie endurecida para una mayor resistencia al desgaste
- Para moleteados hasta una cara lateral (Fig.3)

### + Features

- Recommended for RAA and RGE type knurling
- Frontal feeding by means of 3 jaws simultaneously adjusted (Fig. 1)
- Self - centering system to compensate a misalignment of the lathe turret (Fig. 2)
- Carbide pins
- Anti-wearing treatment of the tool surface
- For knurling up to a shoulder (Fig.3)

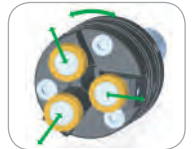

(Fig. 1)

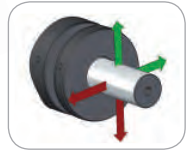

(Fig. 2)



(Fig. 3)



### + Avance Feed

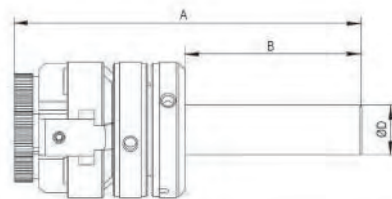

### LONGITUD MÁXIMA DE MOLETEADO (mm) MAXIMUM KNURLING LENGTH (mm)

Modelo Model	Ø Pieza Piece Ø	Longitud (mm) Length (mm)
M17 15	<10	40
M17 25	<14	69
	>14<21	37
	>21<30	17

### + Formas de moleteados realizables Feasible knurling forms

	RAA	RGE 30°	RGE 45°
Tipo de moleteado Knurling form			
Con moleta tipo With knurl type	AA+AA+AA	BL30° + BR30° + BR30°	BL45° + BR45° + BR45°
Avances permitidos Allowed feeds	F	F	F

**R** Moleteados recomendados | Recommended knurlings

### Herramienta | Tool

Código Code	Referencia Reference	Capacidad Capacity	Moleta Knurl	A	B	C	D	Kg
01170301	M17 15.06.1/2"	Ø 4-10 mm	15x6x10/6	113	57,5	44	12,7	1,0
01170101	M17 15.06.16	Ø 4-10 mm	15x6x10/6	113	57,5	44	16	1,0
01170501	M17 25.10.3/4"	Ø 6-30 mm	25x10x15/11	149	57,5	70	19,05	1,4
01170201	M17 25.10.20	Ø 6-30 mm	25x10x15/11	149	57,5	70	20	1,4
01170601	M17 25.10.22	Ø 6-30 mm	25x10x15/11	149	57,5	70	22	1,5
01170701	M17 25.10.25	Ø 6-30 mm	25x10x15/11	149	57,5	70	25	1,5
01170401	M17 25.10.1"	Ø 6-30 mm	25x10x15/11	149	57,5	70	25,4	1,5

### Repuesto | Spare Part

Código Code	Referencia Reference
01983220	EM20/M21
01983200	EAM10





# MOLETEADORES POR CORTE CUT-KNURLING TOOLS



## MFS 89



(Fig. 1)

### + Características

- Recomendado para moleteados tipo RAA
- Cabeza basculante para el alineamiento de la moleta (Fig. 1)
- Eje de HSS
- Ajuste del ángulo de ataque mediante tornillos integrados en el mango

### + Features

- Recommended for RAA type knurling
- Pivoting head for knurl alignment (Fig. 1)
- HSS bushing
- Adjustment of tool clearance angle by threaded studs integrated in the shank

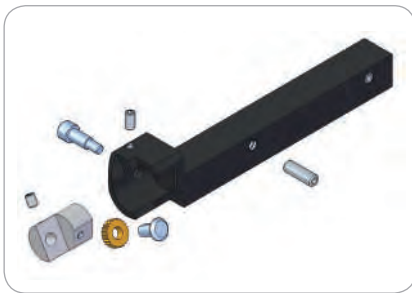

### + Avance Feed

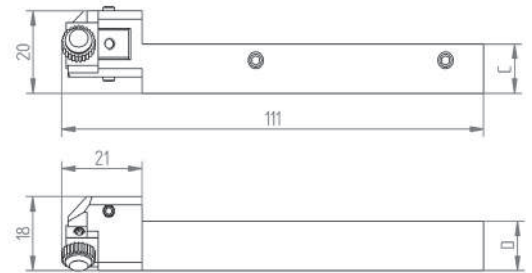
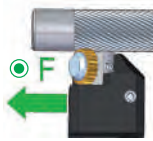

### + Formas de moleteados realizables Feasible knurling forms

	<b>R</b> RAA	RBR 30°	<b>R</b> RAA	RBL 30°
Tipo de moleteado Knurling form				
Con moleta tipo With knurl type	BR30°	AA	BL30°	AA
Con herramienta With tool	Versión derecha R Right - handed R		Versión izquierda L Left - handed L	
Avances permitidos Allowed feeds	F	F	F	F

**R** Moleteados recomendados | Recommended knurling

Herramienta   Tool							
Código Code	Referencia Reference	Versión Version	Capacidad Capacity	Moleta Knurl	C	D	Kg Kg
01090900	MFS 89.25.08 R	R	Ø 1.5 ÷ 12	8.9x2.5x4	8	8	0.2
01091000	MFS 89.25.08 L	L	Ø 1.5 ÷ 12	8.9x2.5x4	8	8	0.2
01091100	MFS 89.25.10 R	R	Ø 1.5 ÷ 12	8.9x2.5x4	10	10	0.2
01091200	MFS 89.25.10 L	L	Ø 1.5 ÷ 12	8.9x2.5x4	10	10	0.2
01091300	MFS 89.25.12 R	R	Ø 1.5 ÷ 12	8.9x2.5x4	12	12	0.2
01091400	MFS 89.25.12 L	L	Ø 1.5 ÷ 12	8.9x2.5x4	12	12	0.2

Repuesto   Spare Part	
Código Code	Referencia Reference
01993300	ES 89.25HSS







# MOLETEADORES POR CORTE CUT-KNURLING TOOLS



## MFS1 14



(Fig. 1)

### + Características

- Recomendado para moleteados tipo RAA
- Cabeza basculante para el alineamiento de la moleta (Fig. 1)
- Eje de HSS+TIN
- Ajuste del ángulo de ataque mediante tornillos integrados en el mango

### + Features

- Recommended for RAA type knurling
- Pivoting head for knurl alignment (Fig. 1)
- HSS+TIN bushing
- Adjustment of tool clearance angle by threaded studs integrated in the shank



### + Avance Feed

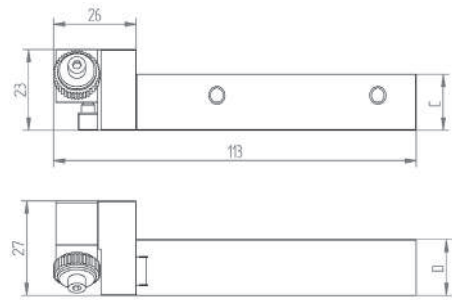
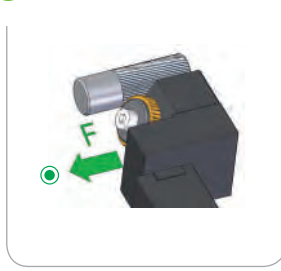

### + Formas de moleteados realizables Feasible knurling forms

	R RAA	R RBR 30°	R RAA	R RBL 30°
Tipo de moleteado Knurling form				
Con moleta tipo With knurl type	BR30°	AA	BL30°	AA
Con herramienta With tool	Versión derecha R Right - handed R		Versión izquierda L Left - handed L	
Avances permitidos Allowed feeds	F	F	F	F

**R** Moleteados recomendados | Recommended knurling

Herramienta   Tool							
Código Code	Referencia Reference	Versión Version	Capacidad Capacity	Moleta Knurl	C	D	Kg Kg
01260100	MFS1 14.53.12 R	R	∅ 3 ÷ 50	14.5x3x5	12	14	0.3
01260200	MFS1 14.53.12 L	L	∅ 3 ÷ 50	14.5x3x5	12	14	0.3
01260300	MFS1 14.53.14 R	R	∅ 3 ÷ 50	14.5x3x5	14	14	0.3
01260400	MFS1 14.53.14 L	L	∅ 3 ÷ 50	14.5x3x5	14	14	0.3
01260500	MFS1 14.53.16 R	R	∅ 3 ÷ 50	14.5x3x5	16	16	0.3
01260600	MFS1 14.53.16 L	L	∅ 3 ÷ 50	14.5x3x5	16	16	0.3

Repuesto   Spare Part		
Código Code	Referencia Reference	
01985600	EAT 14.53	



# MOLETEADORES POR CORTE CUT-KNURLING TOOLS



## MFS 14

### + Características

- Recomendado para moleteados tipo RAA
- Cabeza basculante para el alineamiento de la moleta (Fig. 1)
- Cabeza reversible para trabajar a derechas o izquierdas (Fig. 2)
- Eje de HSS+TIN
- Ajuste del ángulo de ataque mediante tornillos integrados en el mango

### + Features

- Recommended for RAA type knurling
- Pivoting head for knurl alignment (Fig. 1)
- Tool with reversible head able to fit on left-hand or right-hand lathes (Fig. 2)
- HSS+TIN bushing
- Adjustment of tool clearance angle by threaded studs integrated in the shank

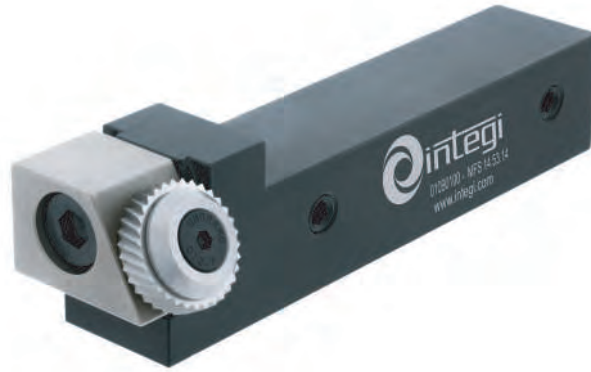

(Fig. 1)



(Fig. 2)

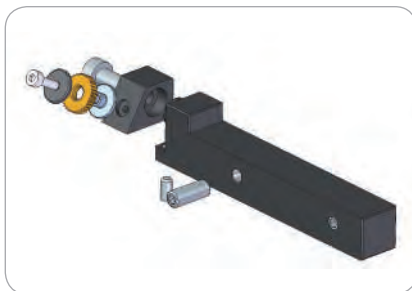

### + Avance Feed

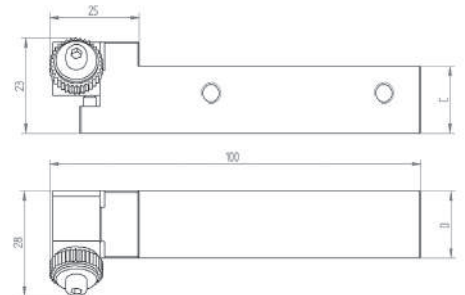

### + Formas de moleteados realizables Feasible knurling forms

	<b>R</b> RAA	RBR 30°	<b>R</b> RAA	RBL 30°
Tipo de moleteado Knurling form				
Con moleta tipo With knurl type	BR30°	AA	BL30°	AA
Con herramienta With tool	Versión derecha R Right - handed R		Versión izquierda L Left - handed L	
Avances permitidos Allowed feeds	F	F	F	F

**R** Moleteados recomendados | Recommended knurling

Herramienta   Tool							
Código Code	Referencia Reference	Versión Version	Capacidad Capacity	Moleta Knurl	C	D	Kg Kg
01090500	MFS 14.53.12	R+L	∅ 3 ÷ 50	14.5x3x5	12	16	0.2
01090100	MFS 14.53.14	R+L	∅ 3 ÷ 50	14.5x3x5	14	16	0.2
01090200	MFS 14.53.16	R+L	∅ 3 ÷ 50	14.5x3x5	16	16	0.2

Repuesto   Spare Part	
Código Code	Referencia Reference
01985600	EAT 14.53





# MOLETEADORES POR CORTE CUT-KNURLING TOOLS



## MFS 21



(Fig. 1)



(Fig. 2)

### + Características

- Recomendado para moleteados tipo RAA
- Cabeza basculante para el alineamiento de la moleta (Fig. 1)
- Cabeza reversible para trabajar a derechas o izquierdas (Fig. 2)
- Eje de HSS+TIN
- Ajuste del ángulo de ataque mediante tornillos integrados en el mango

### + Features

- Recommended for RAA type knurling
- Pivoting head for knurl alignment (Fig.1)
- Tool with reversible head able to fit on lefthand or right-hand lathes (Fig. 2)
- HSS+TIN bushing
- Adjustment of tool clearance angle by threaded studs integrated in the shank

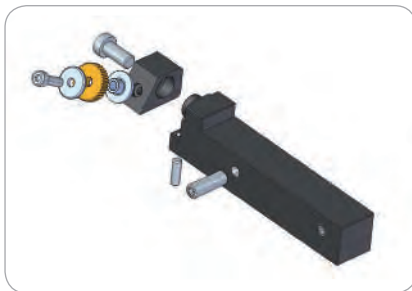

### + Avance Feed

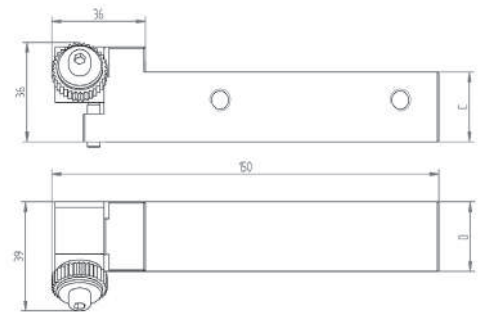

### + Formas de moleteados realizables Feasible knurling forms

	<sup>R</sup> RAA	RBR 30°	<sup>R</sup> RAA	RBL 30°
Tipo de moleteado Knurling form				
Con moleta tipo With knurl type	BR30°	AA	BL30°	AA
Con herramienta With tool	Versión derecha R Right - handed R		Versión izquierda L Left - handed L	
Avances permitidos Allowed feeds	F	F	F	F

<sup>R</sup> Moleteados recomendados | Recommended knurling

Herramienta   Tool							
Código Code	Referencia Reference	Versión Version	Capacidad Capacity	Moleta Knurl	C	D	Kg Kg
01091500	MFS 21.55.3/4"	R+L	Ø 4 ÷ 250	21.5x5x8	19.05	25	0.8
01091600	MFS 21.55.1"	R+L	Ø 4 ÷ 250	21.5x5x8	25.4	25	0.8
01090300	MFS 21.55.20	R+L	Ø 4 ÷ 250	21.5x5x8	20	25	0.8
01090400	MFS 21.55.25	R+L	Ø 4 ÷ 250	21.5x5x8	25	25	0.8

Repuesto   Spare Part	
Código Code	Referencia Reference
01985700	EAT 21.55





# MOLETEADORES POR CORTE CUT-KNURLING TOOLS



## MFS 32

### + Características

- Recomendado para moleteados tipo RAA
- Giro de la cabeza portamoletas mediante tornillo sin fin, para un alineamiento preciso de la moleta (Fig. 1)
- Cuerpo reversible para trabajar a derechas o a izquierdas (Fig. 2)
- Mínimo voladizo entre el amarre y el extremo de la moleta (Fig. 3)
- Máxima rigidez para garantizar una calidad excelente de moleteado.
- Posibilidad de moletear cualquier helice entre 0°-30° (Fig. 4)

### + Features

- Recommended for RAA knurling
- Pivoting head by endless screw, for a precise knurl alignment (Fig. 1)
- Reversible body for righthand or lefthand tool version (Fig. 2)
- Minimum tool overhang (Fig. 3)
- Maximum rigidity to guarantee an excellent knurling quality.
- Possibility of knurling any helix between 0°-30° (Fig. 4)



(Fig. 1)



(Fig. 2)



(Fig. 3)



(Fig. 4)

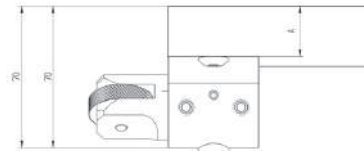
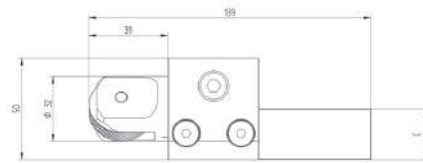

### + Avance Feed



### + Formas de moleteados realizables Feasible knurling forms

	<b>R</b> RAA	RBR 30°	<b>R</b> RAA	RBL 30°
Tipo de moleteado Knurling form				
Con moleta tipo With knurl type	BR30°	AA	BL30°	AA
Con herramienta With tool	Cabeza inclinada 30° a la derecha Knurl head tilted 30° to the right		Cabeza inclinada 30° a la izquierda Knurl head tilted 30° to the left	
Avances permitidos Allowed feeds	F	F	F	F

**R** Moleteados recomendados | Recommended knurling

Herramienta   Tool							
Código Code	Referencia Reference	Versión Version	Capacidad Capacity	Moleta Knurl	C	D	Kg Kg
01230100	MFS 32.08.20	R+L	∅ 50 - 1000	32x8x14	20	25	1.5
01230200	MFS 32.08.25	R+L	∅ 50 - 1000	32x8x14	25	25	1.5
01230300	MFS 32.08.32	R+L	∅ 50 - 1000	32x8x14	32	32	1.5

Repuesto   Spare Part	
Código Code	Referencia Reference
01239901	TCMFS 32





# MOLETEADORES POR CORTE CUT-KNURLING TOOLS



## MFS 42

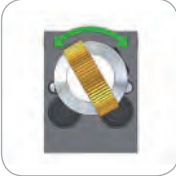

(Fig. 1)

### + Características

- Recomendado para moleteados tipo RAA
- Cabeza basculante para el alineamiento de la moleta (Fig. 1)
- Posibilidad de trabajar a derechas o a izquierdas girando la cabeza
- Eje de HSS

### + Features

- Recommended for RAA type knurling
- Pivoting head for knurl alignment (Fig. 1)
- Tool with reversible head able to fit on left-hand or right-hand lathes
- HSS bushing

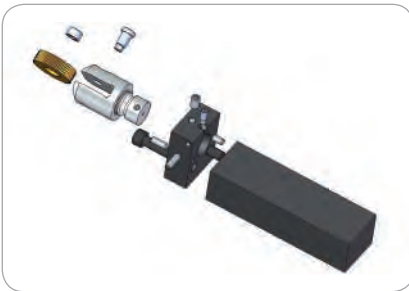

### + Avance Feed

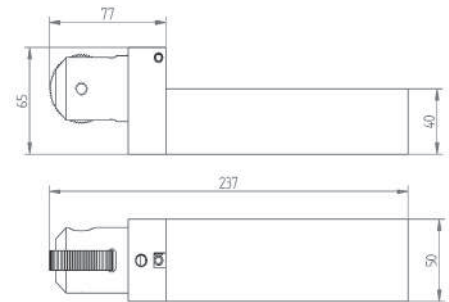

### + Formas de moleteados realizables Feasible knurling forms

	<b>R</b> RAA	RBR 30°	<b>R</b> RAA	RBL 30°
Tipo de moleteado Knurling form				
Con moleta tipo With knurl type	BR30°	AA	BL30°	AA
Con herramienta With tool	Versión derecha R Right - handed R		Versión izquierda L Left - handed L	
Avances permitidos Allowed feeds	<b>F</b>	<b>F</b>	<b>F</b>	<b>F</b>

**R** Moleteados recomendados | Recommended knurling

Herramienta   Tool					
Código Code	Referencia Reference	Versión Version	Capacidad Capacity	Moleta Knurl	Kg Kg
01270100	MFS 42.12.40	R+L	∅ 100 ÷ 3000	42x12x18	7.0

Repuesto   Spare Part		
Código Code	Referencia Reference	
01995901	TCMFS 42	



# MOLETEADORES POR CORTE CUT-KNURLING TOOLS



## MF 89

### + Características

- Recomendado para moleteados tipo RGE
- Ajuste de las moletas según diámetro a moletear mediante escala graduada (Fig. 2)
- Cabeza basculante para el alineamiento de las moletas (Fig. 1)
- Ejes de HSS+TIN
- Ajuste del ángulo de ataque mediante tornillos integrados en el mango

### + Features

- Recommended for RGE type knurling
- Easy setting to the workpiece diameter by means of a graduated scale (Fig. 2)
- Pivoting head for knurls self-centering (Fig. 1)
- HSS+TIN bushing
- Adjustment of tool clearance angle by threaded studs integrated in the shank



(Fig. 1)

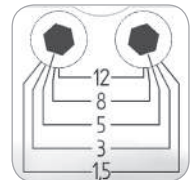

(Fig. 2)

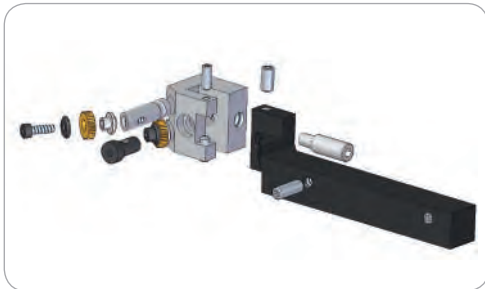
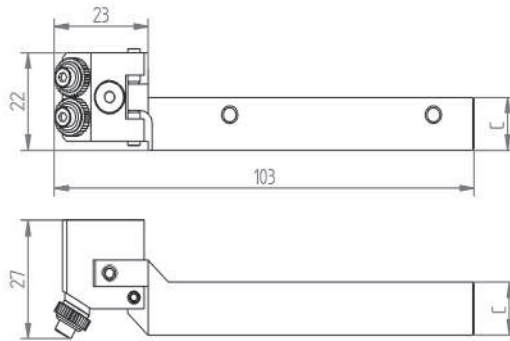

### + Avance Feed



### + Formas de moleteados realizables Feasible knurling forms

	R RGE 30°	R RGE 45°
Tipo de moleteado Knurling form		
Con moleta tipo With knurl type	AA + AA	BL15° + BR15°
Avances permitidos Allowed feeds	F	F

**R** Moleteados recomendados | Recommended knurling

Herramienta   Tool						
Código Code	Referencia Reference	Versión Version	Capacidad Capacity	Moleta Knurl	C	Kg Kg
01101300	MF 89.25.08 R	R	Ø 1.5 ÷ 12	8.9x2.5x4	8	0.2
01101400	MF 89.25.08 L	L	Ø 1.5 ÷ 12	8.9x2.5x4	8	0.2
01101500	MF 89.25.10 R	R	Ø 1.5 ÷ 12	8.9x2.5x4	10	0.2
01101600	MF 89.25.10 L	L	Ø 1.5 ÷ 12	8.9x2.5x4	10	0.2
01101700	MF 89.25.12 R	R	Ø 1.5 ÷ 12	8.9x2.5x4	12	0.2
01101800	MF 89.25.12 L	L	Ø 1.5 ÷ 12	8.9x2.5x4	12	0.2

Repuesto   Spare Part	
Código Code	Referencia Reference
01985500	EAT 89.25







# MOLETEADORES POR CORTE CUT-KNURLING TOOLS



## MF1 14

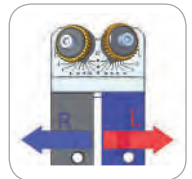

(Fig. 1)

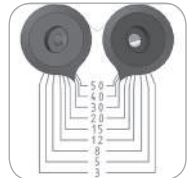

(Fig. 2)

### + Características

- Recomendado para moleteados tipo RGE
- Ajuste de las moletas seg n di metro a moletear mediante escala graduada (Fig. 2)
- Doble posici n del mango para trabajar a derechas o izquierdas (Fig. 1)
- Ejes de HSS+TIN
- Ajuste del ngulo de ataque mediante tornillos integrados en el mango



### + Features

- Recommended for RGE type knurling
- Easy setting to the workpiece diameter by means of a graduated scale (Fig. 2)
- Tool with reversible shank able to lit on left-hand or right-hand lathes (Fig. 1)
- HSS+TIN bushing
- Adjustment of tool clearance angle by threaded studs integrated in the shank

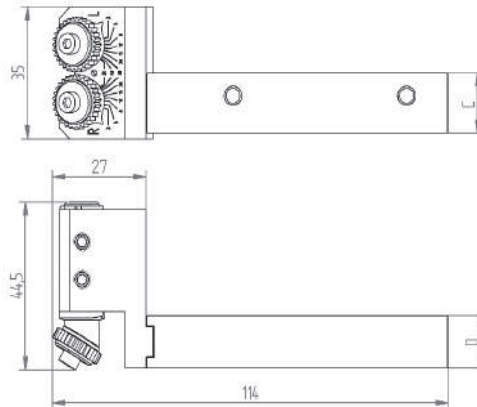
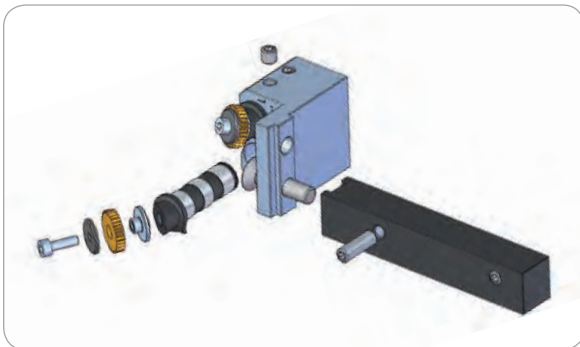

### + Avance Feed

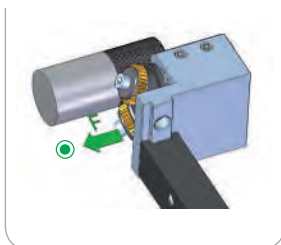

### + Formas de moleteados realizables Feasible knurling forms

	R RGE 30°	R RGE 45°
Tipo de moleteado Knurling form		
Con moleta tipo With knurl type	AA + AA	BL15° + BR15°
Avances permitidos Allowed feeds	F	F

### R Moleteados recomendados | Recommended knurling

Herramienta   Tool							
Código Code	Referencia Reference	Versión Version	Capacidad Capacity	Moleta Knurl	C	D	Kg Kg
01250100	MF1 14.53.12	R+L	Ø 3 ÷ 50	14.5x3x5	12	14	0.5
01250200	MF1 14.53.14	R+L	Ø 3 ÷ 50	14.5x3x5	14	14	0.5
01250300	MF1 14.53.16	R+L	Ø 3 ÷ 50	14.5x3x5	16	16	0.5

Repuesto   Spare Part	
Código Code	Referencia Reference
01985600	EAT 14.53





# MOLETEADORES POR CORTE CUT-KNURLING TOOLS



## MF 14

### + Características

- Recomendado para moleteados tipo RGE
- Ajuste de las moletas según diámetro a moletear mediante escala graduada (Fig. 2)
- Cabeza basculante para el alineamiento de las moletas (Fig. 1)
- Ejes de HSS+TIN
- Ajuste del ángulo de ataque mediante tornillos integrados en el mango

### + Features

- Recommended for RGE type knurling
- Easy setting to the workpiece diameter by means of a graduated scale (Fig. 2)
- Pivoting head for knurls self-centering (Fig. 1)
- HSS+TIN bushing
- Adjustment of tool clearance angle by threaded studs integrated in the shank

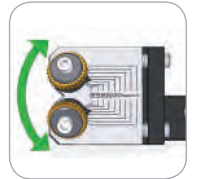

(Fig. 1)

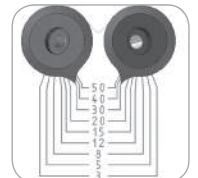

(Fig. 2)

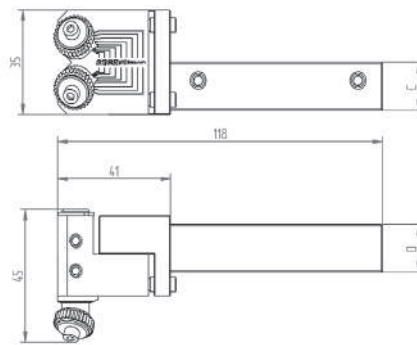
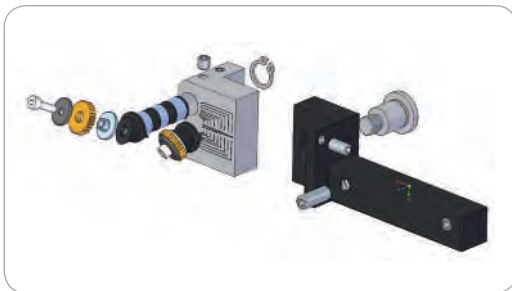

### + Avance Feed



### + Formas de moleteados realizables Feasible knurling forms

	<b>R</b> RGE 30°	<b>R</b> RGE 45°
Tipo de moleteado Knurling form		
Con moleta tipo With knurl type	AA + AA	BL15° + BR15°
Avances permitidos Allowed feeds	F	F

**R** Moleteados recomendados | Recommended knurling

Herramienta   Tool							
Código Code	Referencia Reference	Versión Version	Capacidad Capacity	Moleta Knurl	C	D	Kg Kg
01100900	MF14.53.12 R	R	∅ 3 ÷ 50	14.5x3x5	12	16	0.5
01101000	MF 14.53.12 L	L	∅ 3 ÷ 50	14.5x3x5	12	16	0.5
01100100	MF 14.53.14 R	R	∅ 3 ÷ 50	14.5x3x5	14	16	0.5
01100200	MF 14.53.14 L	L	∅ 3 ÷ 50	14.5x3x5	14	16	0.5
01100300	MF 14.53.16 R	R	∅ 3 ÷ 50	14.5x3x5	16	16	0.5
01100400	MF 14.53.16 L	L	∅ 3 ÷ 50	14.5x3x5	16	16	0.5

Repuesto   Spare Part	
Código Code	Referencia Reference
01985600	EAT 14.53





# MOLETEADORES POR CORTE CUT-KNURLING TOOLS



## MF 21

### + Características

- Recomendado para moleteados tipo RGE
- Ajuste de las moletas según diámetro a moletear mediante escala graduada (Fig. 2)
- Cabeza ajustable en altura para el alineamiento de las moletas (Fig. 1)
- Cabeza reversible para trabajar a derechas o izquierdas (Fig. 3)
- Ejes de HSS+TIN
- Ajuste del ángulo de ataque mediante tornillos integrados en el mango

### + Features

- Recommended for RGE type knurling
- Easy setting to the workpiece diameter by means of a graduated scale (Fig. 2)
- Up & down tool head alignment for knurls centering (Fig. 1)
- Tool with reversible head able to fit on left-hand or right-hand lathes (Fig. 3)
- HSS+TIN bushing
- Adjustment of tool clearance angle by threaded studs integrated in the shank

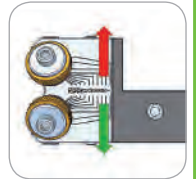

(Fig. 1)

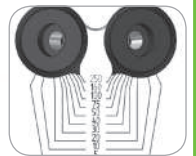

(Fig. 2)

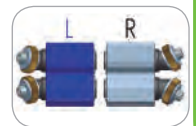

(Fig. 3)

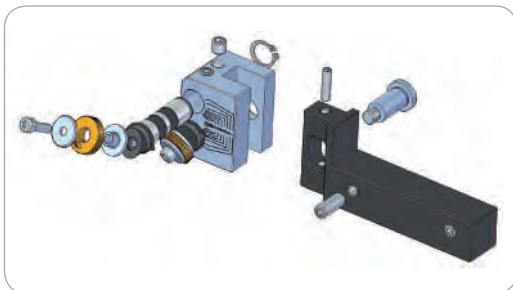
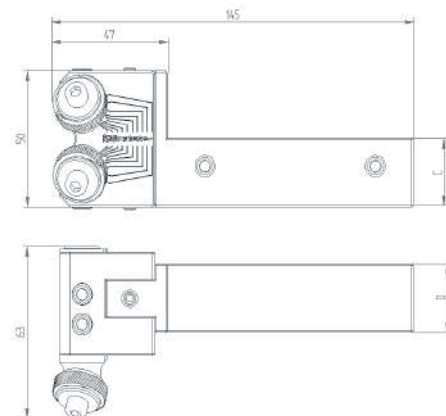

### + Avance Feed

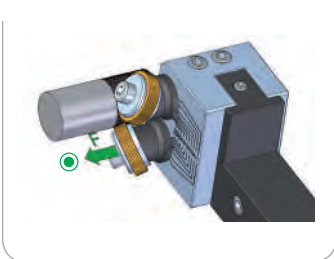

### + Formas de moleteados realizables Feasible knurling forms

	R RGE 30°	R RGE 45°
Tipo de moleteado Knurling form		
Con moleta tipo With knurl type	AA + AA	BL15° + BR15°
Avances permitidos Allowed feeds	F	F

### R Moleteados recomendados | Recommended knurling

Herramienta   Tool							
Código Code	Referencia Reference	Versión Version	Capacidad Capacity	Moleta Knurl	C	D	Kg Kg
01101900	MF 21.55.3/4"	R+L	∅ 5 ÷ 250	21.5x5x8	19.05	25	1.4
01102100	MF 21.55.1"	R+L	∅ 5 ÷ 250	21.5x5x8	25.4	25	1.4
01100500	MF 21.55.20	R+L	∅ 5 ÷ 250	21.5x5x8	20	25	1.4
01100700	MF 21.55.25	R+L	∅ 5 ÷ 250	21.5x5x8	25	25	1.4

Repuesto   Spare Part		
Código Code	Referencia Reference	
01985700	EAT 21.55	



# MOLETEADORES POR CORTE CUT-KNURLING TOOLS



## MF 21 VDI

### + Características

- Recomendado para moleteados tipo RGE
- Ajuste de las moletas según diámetro a moletear mediante escala graduada (Fig. 2)
- Cabeza basculante para el alineamiento de las moletas (Fig. 1)
- Ejes de HSS+TIN

### + Features

- Recommended for RGE type knurling
- Easy setting to the workpiece diameter by means of a graduated scale (Fig. 2)
- Pivoting head for knurl alignment (Fig. 1)
- HSS+TIN bushing

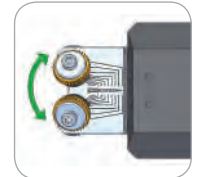

(Fig. 1)

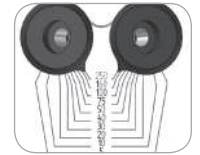

(Fig. 2)

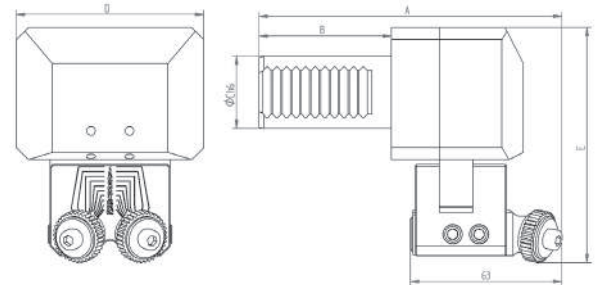
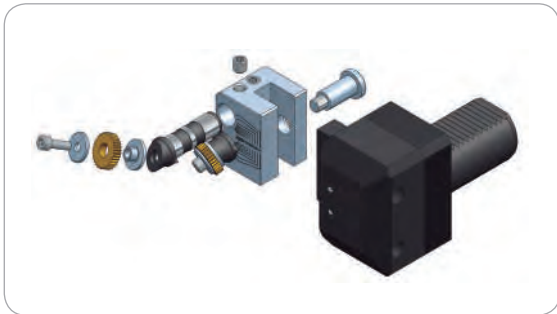

### + Avance Feed

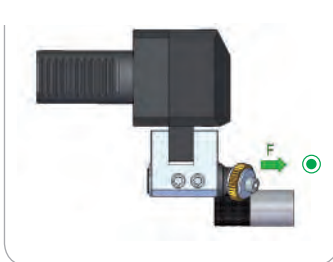

### + Formas de moleteados realizables Feasible knurling forms

	R RGE 30°	R RGE 45°
Tipo de moleteado Knurling form		
Con moleta tipo With knurl type	AA + AA	BL15° + BR15°
Avances permitidos Allowed feeds	F	F

### R Moleteados recomendados | Recommended knurling

Herramienta   Tool										
Código Code	Referencia Reference	Versión Version	Capacidad Capacity	Moleta Knurl	A	B	C	D	E	Kg Kg
01140100	MF 21.55 VDI 30R	R	Ø 5 ÷ 250	21.5x5x8	126	55	30	68	95	2.6
01140200	MF 21.55 VDI 30L	L	Ø 5 ÷ 250	21.5x5x8	126	55	30	68	95	2.6
01140300	MF 21.55 VDI 40R	R	Ø 5 ÷ 250	21.5x5x8	136	63	40	78	98	2.9
01140400	MF 21.55 VDI 40L	L	Ø 5 ÷ 250	21.5x5x8	136	63	40	78	98	2.9

Repuesto   Spare Part	
Código Code	Referencia Reference
01985700	EAT 21.55





# MOLETEADORES POR CORTE CUT-KNURLING TOOLS



## MF 42



(Fig. 1)



(Fig. 2)



(Fig. 3)

### + Características

- Recomendado para moleteados tipo RGE
- Ajuste de las moletas según diámetro a moletear mediante escala graduada (Fig. 3)
- Cabeza ajustable en altura para el alineamiento de las moletas (Fig. 1)
- Cabeza reversible para trabajar a derechas o izquierdas (Fig. 2)
- Ejes de metal duro

### + Features

- Recommended for RGE type knurling
- Easy setting to the workpiece diameter by means of a graduated scale (Fig. 3)
- Up&down tool head alignment for knurls centering (Fig. 1)
- Tool with reversible head able to fit on left-hand or right-hand lathes (Fig. 2)
- Carbide pins

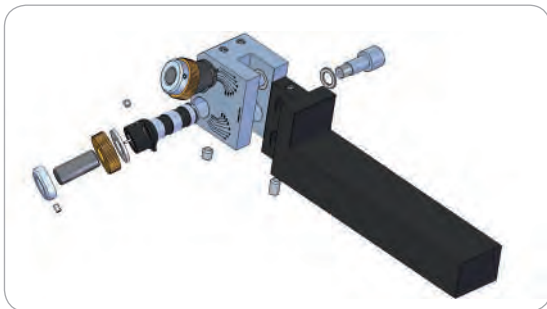
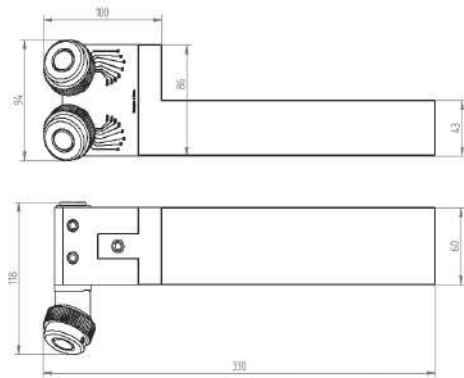

### + Avance Feed



### + Formas de moleteados realizables Feasible knurling forms

	R RGE 30°	R RGE 45°
Tipo de moleteado Knurling form		
Con moleta tipo With knurl type	AA + AA	BL15° + BR15°
Avances permitidos Allowed feeds	F	F

### R Moleteados recomendados | Recommended knurling

Herramienta   Tool					
Código Code	Referencia Reference	Versión Version	Capacidad Capacity	Moleta Knurl	Kg Kg
01240100	MF 42.12.40	R+L	Ø 100 ÷ 3000	42x12x18	9.0

Repuesto   Spare Part	
Código Code	Referencia Reference
01240105	EMMF 42





## KIT MOLETEADORES KNURLING KITS

### + Características

- Kit de moleteado compuesto por una herramienta doble para moleteados cruzados tipo RGE y una herramienta simple para moleteados rectos tipo RAA
- Varios tamaños disponibles
- Suministrado en una estuche de protección de PVD rígido
- Incluye llaves de servicio
- No incluye moletas

### + Features

- Cut knurling kit consisting of a double tool for cross-knurling type RGE and a single tool for straight knurling type RAA
- Available in various sizes
- Supplied in a rigid PVD protection case
- Service keys included
- Knurls not included



Herramienta   Tool			
Código Code	Referencia Reference	Herramientas incluidas Included tools	Capacidad Capacity
01220400	KMF 89-08 R	MF 89.25.08 R + MFS 89.25.08 R	Ø1,5-12
01220500	KMF 89-08 L	MF 89.25.08 L + MFS 89.25.08 L	Ø1,5-12
01220600	KMF 89-10 R	MF 89.25.10 R + MFS 89.25.10 R	Ø1,5-12
01220700	KMF 89-10 L	MF 89.25.10 L + MFS 89.25.10 L	Ø1,5-12
01220800	KMF 89-12 R	MF 89.25.12 R + MFS 89.25.12 R	Ø1,5-12
01220900	KMF 89-12 L	MF 89.25.12 L + MFS 89.25.12 L	Ø1,5-12
01221000	KMF1 14-12 R	MF1 14.53.12 + MFS1 14.53.12 R	Ø3-50
01221100	KMF1 14-12 L	MF1 14.53.12 + MFS1 14.53.12 L	Ø3-50
01221200	KMF1 14-14 R	MF1 14.53.14 + MFS1 14.53.14 R	Ø3-50
01221300	KMF1 14-14 L	MF1 14.53.14 + MFS1 14.53.14 L	Ø3-50
01221400	KMF1 14-16 R	MF1 14.53.16 + MFS1 14.53.16 R	Ø3-50
01221500	KMF1 14-16 L	MF1 14.53.16 + MFS1 14.53.16 L	Ø3-50
01221600	KMF 14-12 R	MF 14.53.12 R + MFS 14.53.12	Ø3-50
01221700	KMF 14-12 L	MF 14.53.12 L + MFS 14.53.12	Ø3-50
01221800	KMF 14-14 R	MF 14.53.14 R + MFS 14.53.14	Ø3-50
01221900	KMF 14-14 L	MF 14.53.14 L + MFS 14.53.14	Ø3-50
01222000	KMF 14-16 R	MF 14.53.16 R + MFS 14.53.16	Ø3-50
01222100	KMF 14-16 L	MF 14.53.16 L + MFS 14.53.16	Ø3-50
01220200	KMF 21-20	MF 21.55.20 + MFS 21.55.20	Ø5-250
01220300	KMF 21-25	MF 21.55.25 + MFS 21.55.25	Ø5-250
01320100	KM4/M5 20.08.20	M4 20.08.20 + M5 20.08.20	Ø8-200
01320200	KM4/M5 20.08.25	M4 20.08.25 + M5 20.08.25	Ø8-200







[www.integi.com](http://www.integi.com)



Autonom a, 5  
E-48250 · Zaldibar · Bizkaia · Spain

Tel: +34 943 17 48 00

[integi@integi.com](mailto:integi@integi.com)



Miembro de / Member of:



Asociación Española de Fabricantes  
de Máquinas-herramienta, Accesorios,  
Componentes y Herramientas